



MAGNETEK
MATERIAL HANDLING

Product Transition Guide IMPULSE®•G+ & VG+ Series 3 to Series 4



IMPULSE®•G+ & VG+ Series 4 Transition Guide

Product Transition Guide

IMPULSE®•G+ & VG+ Series 4

Page Intentionally Left Blank

Product Transition Guide

Table of Contents

1.1	Overview	4
1.2	Drive Replacement Checklist	4
1.3	Ratings Summary	6
1.4	Digital Operator Comparison	8
1.5	Terminals	9
	Main Circuit Terminals	9
	Control Circuit Terminals	10
1.6	Terminal Size and Wire Gauge Comparison	12
1.7	Dimensions, Installation Space and Substitution Material	25
	Drive Dimension Comparison	25
	IMPULSE® G+/VG+ Series 4 Drive Options	27
1.8	Parameter Cross Reference	31

Product Transition Guide

IMPULSE®•G+ & VG+ Series 4

1.1 Overview

This purpose of this document is to provide an easy transition from the G+/VG+ Series 3 to the G+/VG+ Series 4. For the advanced portion, please refer to the G+/VG+ Series 4 Instruction Manual (P/N 144-23910).

1.2 Drive Replacement Checklist

	Item	Checkpoints	Checked?
Hardware	Basic	<ul style="list-style-type: none"> • Can the existing mounting holes be used? Check if the new drive dimensions are different than the current drive. <ul style="list-style-type: none"> – Verify that the existing dimensions reference in Section 1.7, “Dimensions, installation space and substitution material” of this manual compares the sizes of the current and new unit. If a mechanical substitution kit is necessary, it is referenced in Section 1.7. 	
		<p>< Digital operator ></p> <ul style="list-style-type: none"> • Was a remote operator connected to the current unit? <ul style="list-style-type: none"> – If so, do not attempt to connect the G+ Series 3 remote operator to the G+ Series 4, as they are incompatible. 	
	Main and Control Terminals	<p>< Wire Length ></p> <ul style="list-style-type: none"> • In the replacement drive, the main and control circuit terminals may be mounted in different positions. Check to ensure all cables are long enough to be connected to the new unit. 	
		<p>< Main circuit wires and terminal specifications ></p> <ul style="list-style-type: none"> • Compare the occupied terminals of the current unit with the new drive’s terminals (shape, size, etc.), and verify that the wires fit in the new unit’s terminals, using Section 1.5 “Terminals”, specifically “Control Terminal Sizes and Wire Sizes” of this document. 	
Software	Parameter	<p>< Check the parameter settings ></p> <ul style="list-style-type: none"> • Read the parameter settings of the current unit and perform a parameter conversion to the new parameters. <ul style="list-style-type: none"> – Use IMPULSE® Link for conversion. – Consult Magnetek Service for conversion assistance. – If there is special software installed or parameters appear that are not mentioned in this document, contact your Magnetek representative. 	

Product Transition Guide

IMPULSE®•G+ & VG+ Series 4

	Item	Checkpoints	Checked?
Options, Others	Option Cards	<p>< Is an option card installed? ></p> <ul style="list-style-type: none"> • Check if any option card is installed. <ul style="list-style-type: none"> – If an option card is installed, get the equivalent option card for the G+ Series 4. – Never attempt to apply G+ Series 3 option cards to the G+ Series 4 unit. – The option card on the G+ Series 4 may have a different connector on the G+ Series 3. Make sure that the connectors fit into the new option card before using it. 	
	Others	<p>< Is a braking resistor installed? ></p> <ul style="list-style-type: none"> • Check if a braking resistor is installed on the current drive. <ul style="list-style-type: none"> – Inspect the braking resistor for physical damage or wear before connecting it to the new drive. – Inspect the DB wiring for cracking and possible shorts. – Connect the braking resistor to the equivalent terminals on the new unit. – The terminals might have a different location in the new drive; check to ensure that existing wiring is long enough to reach the new terminal location. – Verify terminal differences. 	
		<p>< Is a braking unit installed? ></p> <ul style="list-style-type: none"> • Check if a braking unit is used in the current installation. <ul style="list-style-type: none"> – Inspect the braking unit for physical damage or wear before connecting it to the new drive. – Connect the braking unit to the equivalent terminals on the new unit. – The terminals might have a different location in the new drive; check to ensure that existing wiring is long enough to reach the new terminal location. 	
		<p>< Is an AC reactor or DC choke installed? ></p> <ul style="list-style-type: none"> • Check if an AC reactor or DC choke is used in the current installation. <ul style="list-style-type: none"> – Inspect the reactor or choke and wiring for physical damage or wear before connecting it to the new drive. – Make sure that the reactor or choke data are appropriate for the replacement drive. – The terminals might have a different location in the new drive; check to ensure that existing wiring is long enough to reach the new terminal location. 	

• Refer to the instruction manual for questions about installation, parameter settings or detailed parameter/function descriptions.

Product Transition Guide

IMPULSE®•G+ & VG+ Series 4

1.3 Ratings Summary

The following table summarizes the output current ratings for the G+ Series 4 and G+ Series 3 with respect to the specific drive model.

Rated Input Voltage	G+ Series 3 Drive Model Number (-AFG+/FVG+)	Heavy Duty		G+ Series 4 Drive Model Number (-G+/VG+S4)	Heavy Duty	
		Rated Output Current (Amps)	Nominal HP		Rated Output Current (Amps)	Nominal HP
230V, 3-Φ	N/A	N/A	N/A	2003	3.2	0.5
	N/A	N/A	N/A	2005	5.0	0.75
	2007	7.0	1.0	2007	6.9	1.0
	N/A	N/A	N/A	2008	8.0	2.0
	2009	9.6	2.0	2011	11	2.0
	N/A	N/A	N/A	2014	14.0	3.0
	2015	15.2	3.0	2017	17.5	3.0
	2023	23	5.0	2025	25	5.0
	2031	31	7.5	2033	33	7.5
	2045	45	10	2047	47	10
	2058	58	15	2060	60	15
	2071	71	20	2075	75	20
	2085	85	30	2085	85	30
	N/A	N/A	N/A	2115	115	40
	2145	145	50	2145	145	50
	N/A	N/A	N/A	2180	180	60
	2215	215	75	2215	215	75
	2283	283	100	2283	283	100
	2346	346	125	2346	346	125
N/A	N/A	N/A	2415	415	150	

Product Transition Guide

IMPULSE®•G+ & VG+ Series 4



Rated Input Voltage	G+ Series 3 Drive Model Number (-AFG+/FVG+)	Heavy Duty		G+ Series 4 Drive Model Number (-G+/VG+S4)	Heavy Duty	
		Rated Output Current (Amps)	Nominal HP		Rated Output Current (Amps)	Nominal HP
460V, 3-Φ	4001	1.8	0.5	4001	1.8	0.5
	4002	2.1	1.0	4003	3.4	1.0
	4003	3.7	2.0	4004	4.8	2.0
	4005	5.3	3.0	4005	5.5	3.0
	N/A	N/A	N/A	4007	7.2	5.0
	4008	8.7	5.0	4009	9.2	5.0
	4012	12.5	7.5	4014	14.8	7.5
	4017	17	10	4018	18	10
	4024	24	15	4024	24	15
	4031	31	20	4031	31	20
	4039	39	25	4039	39	25
	4045	45	30	4045	45	30
	4060	60	40	4060	60	40
	4075	75	50	4075	75	50
	4091	91	60	4091	91	60
	4112	112	75	4112	112	75
	4150	150	100	4150	150	100
	4180	180	125	4180	180	125
	N/A	N/A	N/A	4216	216	150
	4260	260	150	4260	260	200
4304	304	250	4304	304	250	
4370	370	300	4370	370	300	
4477	477	350	4450	450	350	
4590	590	500	4605	605	500	

Product Transition Guide

IMPULSE®•G+ & VG+ Series 4

1.4 Digital Operator Comparison

- Enhanced LCD operator with built-in copy function and parameter verify for the IMPULSE®•G+ & VG+ Series 4
- Soft keys simplify operation and programming
- LCD Contrast Adjustment
- Common parameter groupings for easy transition and set-up
- The IMPULSE®•G+ & VG+ Series 4 have a new layout for faster parameter selection

IMPULSE®•G+ & VG+ Series 3 LCD Operator	IMPULSE®•G+ & VG+ Series 4 LCD Operator
LCD Backlit Display 5 Line x 16 Characters	LCD Backlit Display 5 Line x 16 Characters New Button Layout Soft Keys (F1/F2) Smaller
	

- A Quick Start menu is added to aid in simple start up
- The Quick Start menu consists of 26 parameters. The advanced menu offers full parameter access.

Menu Structure Comparison

IMPULSE®•G+ & VG+ Series 3	IMPULSE®•G+ & VG+ Series 4
Operation "DRIVE"	Operation
Quick Setting "QUICK"	Auto-Tuning
Programming "ADV"	Programming
Modified Constants "VERIFY"	Quick Settings
Auto-Tuning "A.TUNE"	Modified Constants
--	Monitor Menu

1.5 Terminals

Main Circuit Terminals

- As G+ Series 3 and G+ Series 4 drive models may have different terminal sizes (depending on capacity), the terminal must be carefully checked before replacement.
- The main terminal functionality has not been changed between the G+ Series 3 and the G+ Series 4.

Main Terminals		Note
G+ Series 3	G+ Series 4	
R/L1	R/L1	Main circuit power supply input, connects line power to the drive
S/L2	S/L2	
T/L3	T/L3	
U/T1	U/T1	Drive Output, connects to the motor
V/T2	V/T2	
W/T3	W/T3	
B1	B1	Braking resistor
B2	B2	
+2	+2	DC reactor connection (+1, +2) (remove shorting bar)
+1	+1	DC power supply input (+1, -)
—	+3	Braking unit connection (+3, -)
	—	Ground Terminal (10Ω or less)

Product Transition Guide

IMPULSE®•G+ & VG+ Series 4

Control Circuit Terminals

- "—" indicates that an equivalent terminal on the other drive model does not exist.
- G+ Series 4 Defaults are listed in parentheses.
- Terms
 - ❑ MFDI: Multi-Function Digital Input
 - ❑ MFDO: Multi-Function Digital Output
 - ❑ MFAI: Multi-Function Analog Input
 - ❑ MFAO: Multi-Function Analog Output

Control Terminals		Function	Signal Level	
G+ Series 3	G+ Series 4		G+ Series 3	G+ Series 4
S1	S1	MFDI 1 (Run Forward)	Photo-coupler isolation 24 VDC, 8mA 120 VAC (with GIF7)	Photo-coupler isolation 120 VAC (S4IF)
S2	S2	MFDI 2 (Run Reverse)		
S3	S3	MFDI 3 (Speed 2)		
S4	S4	MFDI 4 (Speed 3)		
S5	S5	MFDI 5 (Speed 4)		
S6	S6	MFDI 6 (Speed 5)		
S7	S7	MFDI 7 (External Fault)		
S8	S8	MFDI 8 (Microspeed Gain 1)		
X2	X2	MFDI Common	--	--
M0, M1	M0, M1	MFDO (Brake Release)	Form A Relay: 250 VAC, 1A 30 VDC, 1A	Form A Relay: 250 VAC, 1A 30 VDC, 1A
M2, M3, M4	M2, M3	MFDO (X-Press Programming)	Form A Relay Contact Capacity: 250 VAC, 1A 30 VDC, 1A	Form A Relay: 250 VAC, 1A 30 VDC, 1A
M5, M6	M5, M6	MFDO (X-Press Programming)	Form A Relay Contact Capacity: 250 VAC, 1A 30 VDC, 1A	Form A Relay: 250 VAC, 1A 30 VDC, 1A
MA, MB, MC	MA, MB, MC	Fault annunciate Terminals MA-MC: N/O Terminals MB-MC: N/C	Form C Relay: 250 VAC, 1A 30 VDC, 1A	Form C Relay: 250 VAC, 1A 30 VDC, 1A
+V	+V	Power supply for analog inputs	+15 VDC, 20mA	+10.5 VDC, 20mA
-V	-V	Power supply for analog inputs	-15 VDC, 20mA	-10.5 VDC, 20mA
A1	A1	MFAI 1 (Master Frequency Reference)	-10 to +10V (20kΩ) 0 to +10V (20kΩ)	-10 to +10V (20kΩ) 0 to +10V (20kΩ)
A2	A2	MFAI 2 (Not Used)	-10 to +10V (20kΩ) 0 to +10V (20kΩ) 4 to 20mA (250Ω)	-10 to +10V (20kΩ) 0 to +10V (20kΩ) 4 to 20mA (250Ω)
A3	A3	MFAI 3 (Master Frequency Reference)	-10 to +10V (20kΩ) 0 to +10V (20kΩ)	-10 to +10V (20kΩ) 0 to +10V (20kΩ)
AC	AC	Analog Common	--	--
E (G)	E (G)	Ground for shielded lines and option cards	--	--

Product Transition Guide

IMPULSE®•G+ & VG+ Series 4







Control Terminals		Function	Signal Level	
G+ Series 3	G+ Series 4		G+ Series 3	G+ Series 4
RP	RP	Multi-Function Pulse Train Input	0 to 32kHz (3k) +5% High level voltages 3.5 to 13.2 Low level voltages 0.0 to 0.8 Duty Cycle (on/off) 30% to 70%	Input Freq.: 0 to 32 kHz Duty Cycle: 30 to 70% High level: 3.5 to 13.2 VDC Low Level: 0 to 0.8 VDC Input Impedance: 3kΩ
MP	MP	Pulse train output (Output frequency)	0 to 32kHz ±5% output (load: 1.5k)	32 kHz (max)
FM	FM	MFAO 1 (Output frequency)	0 to ±10VDC Max. ±5% 2mA or less 4 to 20 mA	-10 to +10V, 2mA 0 to +10V, 2mA 4 to 20 mA
AC	AC	Analog Common	--	--
AM	AM	MFAO 2 (Output current)	0 to ±10VDC Max. ±5% 2mA or less 4 to 20 mA	-10 to +10V, 2mA 0 to +10V, 2mA
—	H1	Safe Disable input 1	--	24 VDC, 8mA Internal Impedance: 3.3kΩ
—	H2	Safe Disable input 2	--	
—	HC	Safe Disable common	--	
—	DM+	Safety monitor output	--	48 VDC, 8mA
—	DM-	Safety monitor output common	--	--
R+	R+	Receive (+)	Differential input, PHC isolation	RS-485/422 Line Driver 115.2 kbps (max)
R-	R-	Receive (-)		
S+	S+	Transmit (+)	Differential output, PHC isolation	
S-	S-	Transmit (-)		
IG	IG	Shield connection	--	--

Product Transition Guide

IMPULSE®•G+ & VG+ Series 4







1.6 Terminal Size and Wire Gauge Comparison

3-Phase 200V Class Main Circuit Terminal Size and Gauge

IMPULSE®•G+ & VG+		Terminal Signal	Terminal Screw	Tightening Torque N. m (lb.in.)	Possible Gauges (AWG/kcmil)	Recommended Gauge (AWG/ kcmil)
Series 4	2003 2005	R/L1, S/L2, T/L3, U/T1, V/T2, W/T3, -, +1, +2, B1, B2, 	M4	1.2 to 1.5 (10.6 to 13.3)	14 to 10	14 to 10, 14 (Ground)
Series 3	2007	R/L1, S/L2, T/L3, U/T1, V/T2, W/T3, -, +1, +2, B1, B2	M4	1.2 to 1.5 (10.6 to 13.3)	14 to 10	12
Series 4	2007 2008	R/L1, S/L2, T/L3, U/T1, V/T2, W/T3, -, +1, +2, B1, B2, 	M4	1.2 to 1.5 (10.6 to 13.3)	14 to 10	14 to 10, 12 (Ground)
Series 3	2009	R/L1, S/L2, T/L3, U/T1, V/T2, W/T3, -, +1, +2, B1, B2, 	M4	1.2 to 1.5 (10.6 to 13.3)	14 to 10	12
Series 4	2011	R/L1, S/L2, T/L3, U/T1, V/T2, W/T3, -, +1, +2, B1, B2, 	M4	1.2 to 1.5 (10.6 to 13.3)	14 to 10	14 to 10
			M4	1.2 to 1.5 (10.6 to 13.3)	14 to 10	12
Series 3	2015	R/L1,S/L2,T/L3, U/T1,V/T2,W/T3, -,+1, +2, B1, B2, 	M4	1.2 to 1.5 (10.6 to 13.3)	12 to 10	12, 10 (Ground)
Series 4	2014 2017	R/L1,S/L2,T/L3, -,+1, +2	M4	1.2 to 1.5 (10.6 to 13.3)	12 to 10	2014:14 to 10 2017: 12 to 10
		U/T1,V/T2,W/T3, 	M4	1.2 to 1.5 (10.6 to 13.3)	12 to 10	2014:14 to 10 2017: 12 to 10 10 (Ground)
		B1, B2	M4	1.2 to 1.5 (10.6 to 13.3)	14 to 10	—
Series 3	2023	R/L1, S/L2, T/L3, U/T1, V/T2, W/T3, -, +1, +2, B1, B2, 	M4	1.2 to 1.5 (10.6 to 13.3)	10	12, 10 (Ground)







Product Transition Guide

IMPULSE®•G+ & VG+ Series 4

IMPULSE®•G+ & VG+		Terminal Signal	Terminal Screw	Tightening Torque N. m (lb.in.)	Possible Gauges (AWG/kcmil)	Recommended Gauge (AWG/ kcmil)
Series 4	2025	R/L1, S/L2, T/L3, -, +1, +2	M4	1.2 to 1.5 (10.6 to 13.3)	10 to 6	8
		U/T1, V/T2, W/T3	M4	1.2 to 1.5 (10.6 to 13.3)	10 to 6	8
		B1, B2	M4	1.2 to 1.5 (10.6 to 13.3)	14 to 10	—
			M5	2 to 2.5 (17.7 to 22.1)	10 to 8	8
Series 3	2031	R/L1, S/L2, T/L3, U/T1, V/T2, W/T3, -, +1, +2, B1, B2, 	M5	2.5 (21.99)	8 to 6	8, 10 (Ground)
Series 4	2033	R/L1, S/L2, T/L3, -, +1, +2	M4	1.2 to 1.5 (10.6 to 13.3)	8 to 6	8 to 6
		U/T1, V/T2, W/T3	M4	1.2 to 1.5 (10.6 to 13.3)	8 to 6	8 to 6
		B1, B2	M4	1.2 to 1.5 (10.6 to 13.3)	12 to 10	—
			M5	2 to 2.5 (17.7 to 22.1)	10 to 8	8
Series 3	2045	R/L1, S/L2, T/L3, U/T1, V/T2, W/T3, -, +1, +2, B1, B2, 	M5	2.5 (21.99)	6 to 4	6, 10 (Ground)
Series 4	2047	R/L1, S/L2, T/L3, -, +1, +2	M6	4 to 6 (35.4 to 53.1)	6 to 4	6 to 4
		U/T1, V/T2, W/T3	M6	4 to 6 (35.4 to 53.1)	6 to 4	6 to 4
		B1, B2	M5	2 to 2.5 (17.7 to 22.1)	10 to 6	—
			M6	4 to 6 (35.4 to 53.1)	8 to 6	6
Series 3	2058	R/L1, S/L2, T/L3, U/T1, V/T2, W/T3, -, +1, +2	M6	4 to 5 (35.2 to 43.99)	4 to 2	4
		B1, B2	M5	2.5 (21.99)	8 to 6	—
			M6	4 to 5 (35.2 to 43.99)	4	8





Product Transition Guide

IMPULSE®•G+ & VG+ Series 4

IMPULSE®•G+ & VG+		Terminal Signal	Terminal Screw	Tightening Torque N. m (lb.in.)	Possible Gauges (AWG/kcmil)	Recommended Gauge (AWG/ kcmil)
Series 4	2060	R/L1, S/L2, T/L3, -, +1, +2	M8	9 to 11 (79.7 to 97.4)	4 to 3	4 to 2
		U/T1, V/T2, W/T3	M8	9 to 11 (79.7 to 97.4)	4 to 3	4 to 2
		B1, B2	M5	2 to 2.5 (17.7 to 22.1)	8 to 6	—
			M6	4 to 6 (35.4 to 53.1)	6 to 4	6
Series 3	2071	R/L1, S/L2, T/L3, U/T1, V/T2, W/T3, -, +1, +2	M8	9 to 10 (79.2 to 87.97)	3 to 2	2
		B1, B2	M5	2.5 (21.99)	8 to 6	—
			M6	4 to 5 (35.2 to 43.99)	4	8
Series 4	2075	R/L1, S/L2, T/L3, -, +1, +2	M8	9 to 11 (79.7 to 97.4)	3 to 2	4 to 2
		U/T1, V/T2, W/T3	M8	9 to 11 (79.7 to 97.4)	3 to 2	4 to 2
		B1, B2	M5	2 to 2.5 (17.7 to 22.1)	6	—
			M6	4 to 6 (35.4 to 53.1)	6 to 4	6
Series 3	2085	R/L1, S/L2, T/L3, U/T1, V/T2, W/T3, -, +1, R1/L11, S1/L21, T1/L31	M8	9 to 10 (79.2 to 87.97)	—	2
		+3	M6	4 to 5 (35.2 to 43.99)	—	—
			M8	9 to 10 (79.2 to 87.97)	—	6
Series 4	2085	R/L1, S/L2, T/L3, U/T1, V/T2, W/T3	M8	9 to 11 (79.7 to 97.4)	3 to 1/0	2 to 1/0
		-, +1	M8	9 to 11 (79.7 to 97.4)	2 to 1/0	—
		B1, B2	M8	9 to 11 (79.7 to 97.4)	6 to 1/0	—
			M8	9 to 11 (79.7 to 97.4)	6 to 4	6
Series 4	2115	R/L1, S/L2, T/L3, U/T1, V/T2, W/T3	M10	18 to 23 (159 to 204)	1 to 2/0	2 to 1/0
		-, +1	M10	18 to 23 (159 to 204)	1/0 to 3/0	—
		B1, B2	M10	18 to 23 (159 to 204)	4 to 2/0	—
			M8	9 to 11 (79.7 to 97.4)	4	4





Product Transition Guide

IMPULSE®•G+ & VG+ Series 4

IMPULSE®•G+ & VG+		Terminal Signal	Terminal Screw	Tightening Torque N. m (lb.in.)	Possible Gauges (AWG/kcmil)	Recommended Gauge (AWG/ kcmil)
Series 3	2145	R/L1, S/L2, T/L3, U/T1, V/T2, W/T3, -, +1, R1/L11, S1/L21, T1/L31	M10	17.6 to 22.5 (154.8 to 197.9)	—	4/0
		+3	M8	8.8 to 10.8 (77.4 to 95.0)	—	—
			M10	17.6 to 22.5 (154.8 to 197.9)	—	2
		r/l 1, s/l 2	M4	1.3 to 1.4 (11.4 to 12.3)	—	16
Series 4	2145	R/L1, S/L2, T/L3, U/T1, V/T2, W/T3	M10	18 to 23 (159 to 204)	2/0 to 4/0, 3/0 to 4/0 (T1-3)	1/0 to 2/0
		-, +1	M10	18 to 23 (159 to 204)	1 to 4/0	—
		+3	M10	18 to 23 (159 to 204)	1/0 to 4/0	—
			M10	18 to 23 (159 to 204)	4 to 2	4
Series 4	2180	R/L1, S/L2, T/L3	M10	18 to 23 (159 to 204)	1/0 to 2/0	1/0 to 2/0
		U/T1, V/T2, W/T3	M10	18 to 23 (159 to 204)	1/0 to 2/0	1/0 to 2/0
		-, +1	M10	18 to 23 (159 to 204)	1 to 4/0	—
		+3	M10	18 to 23 (159 to 204)	1/0 to 4/0	—
			M10	18 to 23 (159 to 204)	4 to 1/0	4
Series 3	2215	R/L1, S/L2, T/L3, -, +1	M10	17.6 to 22.5 (154.8 to 197.9)	—	250 2-2/0
		U/T1, V/T2, W/T3, R1/L11, S1/L21, T1/L31	M10	17.6 to 22.5 (154.8 to 197.9)	—	250 2-2/0
		+3	M8	8.8 to 10.8 (77.4 to 95.0)	—	—
			M10	17.6 to 22.5 (154.8 to 197.9)	—	4
		r/l 1, s/l 2	M4	1.3 to 1.4 (11.4 to 12.3)	—	16
Series 4	2215	R/L1, S/L2, T/L3	M12	32 to 40 (283 to 354)	3/0 to 300	250 2-2/0
		U/T1, V/T2, W/T3	M12	32 to 40 (283 to 354)	3/0 to 300	250 2-2/0
		-, +1	M12	32 to 40 (283 to 354)	3/0 to 300	—
		+3	M10	18 to 23 (159 to 204)	2 to 300	—
			M12	32 to 40 (283 to 354)	3 to 300	4

Product Transition Guide





IMPULSE®•G+ & VG+ Series 4

IMPULSE®•G+ & VG+		Terminal Signal	Terminal Screw	Tightening Torque N. m (lb.in.)	Possible Gauges (AWG/kcmil)	Recommended Gauge (AWG/ kcmil)
Series 3	2283	-, +1	M12	31.4 to 39.2 (276.2 to 344.8)	—	3/0×2P
		R/L1, S/L2, T/L3, U/T1, V/T2, W/T3, R1/L11, S1/L21, T1/L31	M10	17.6 to 22.5 (154.8 to 197.9)	—	350 2-3/0
		+3	M8	8.8 to 10.8 (77.4 to 95.0)	—	—
			M12	31.4 to 39.2 (276.2 to 344.8)	—	2
		r/ℓ 1, Δ/ℓ 2	M4	1.3 to 1.4 (11.4 to 12.3)	—	16
Series 4	2283	R/L1, S/L2, T/L3	M12	32 to 40 (283 to 354)	3/0 to 300	350 2-3/0
		U/T1, V/T2, W/T3	M12	32 to 40 (283 to 354)	3/0 to 300	350 2-3/0
		-, +1	M12	32 to 40 (283 to 354)	3/0 to 300	—
		+3	M10	18 to 23 (159 to 204)	3/0 to 300	—
			M12	32 to 40 (283 to 354)	2 to 300	2
Series 3	2346	R/L1, S/L2, T/L3, -, +1, R1/L11, S1/L21, T1/L31	M12	31.4 to 39.2 (276.2 to 344.8)	—	400 2-250
		U/T1, V/T2, W/T3	M12	31.4 to 39.2 (276.2 to 344.8)	—	400 2-250
		+3	M8	8.8 to 10.8 (77.4 to 95.0)	—	—
			M12	31.4 to 39.2 (276.2 to 344.8)	—	2
		r/ℓ 1, Δ/ℓ 2	M4	1.3 to 1.4 (11.4 to 12.3)	—	16
Series 4	2346	R/L1, S/L2, T/L3	M12	32 to 40 (283 to 354)	4/0 to 600	400 2-250
		U/T1, V/T2, W/T3	M12	32 to 40 (283 to 354)	4/0 to 600	400 2-250
		-, +1	M12	32 to 40 (283 to 354)	250 to 600	—
		+3	M10	18 to 23 (159 to 204)	3/0 to 600	—
			M12	32 to 40 (283 to 354)	1 to 350	1

Product Transition Guide IMPULSE®•G+ & VG+ Series 4







IMPULSE®•G+ & VG+		Terminal Signal	Terminal Screw	Tightening Torque N. m (lb.in.)	Possible Gauges (AWG/kcmil)	Recommended Gauge (AWG/ kcmil)
Series 4	2415	R/L1, S/L2, T/L3	M12	32 to 40 (283 to 354)	250 to 600	400 2-250
		U/T1, V/T2, W/T3	M12	32 to 40 (283 to 354)	300 to 600	400 2-250
		-, +1	M12	32 to 40 (283 to 354)	300 to 600	—
		+3	M10	18 to 23 (159 to 204)	3/0 to 600	—
			M12	32 to 40 (283 to 354)	1 to 350	1

3-Phase 400V Class Main Circuit Terminal Size and Gauge

IMPULSE®•G+ & VG+		Terminal Signal	Terminal Screw	Tightening Torque N. m (lb.in.)	Possible Gauges (AWG/kcmil)	Recommended Gauge (AWG/ kcmil)
Series 3	4001 4002	R/L1, S/L2, T/L3, U/T1, V/T2, W/T3, -, +1, +2, B1, B2, 	M4	1.2 to 1.5 (10.6 to 13.2)	14 to 10	12
Series 4	4001 4003	R/L1, S/L2, T/L3, U/T1, V/T2, W/T3, -, +1, +2, B1, B2, 	M4	1.2 to 1.5 (10.6 to 13.2)	14 to 10	14 to 10, 12 (Ground)
Series 3	4003 4005	R/L1, S/L2, T/L3, U/T1, V/T2, W/T3, -, +1, +2, B1, B2, 	M4	1.2 to 1.5 (10.6 to 13.2)	14 to 10	12
Series 4	4004 4005	R/L1, S/L2, T/L3, U/T1, V/T2, W/T3, -, +1, +2, B1, B2	M4	1.2 to 1.5 (10.6 to 13.2)	14 to 10	14 to 10
	4007		M4	1.2 to 1.5 (10.6 to 13.2)	14 to 10	10
Series 3	4012	R/L1, S/L2, T/L3, U/T1, V/T2, W/T3, -, +1, +2, B1, B2,	M4	1.2 to 1.5 (10.6 to 13.2)	12 to 10	12
			M4	1.2 to 1.5 (10.6 to 13.2)	14 to 10	12







Product Transition Guide

IMPULSE®•G+ & VG+ Series 4

IMPULSE®•G+ & VG+		Terminal Signal	Terminal Screw	Tightening Torque N. m (lb.in.)	Possible Gauges (AWG/kcmil)	Recommended Gauge (AWG/ kcmil)
Series 4	4014	R/L1, S/L2, T/L3, U/T1, V/T2, W/T3, -, +1, +2	M4	1.2 to 1.5 (10.6 to 13.2)	12 to 6	12 to 6
		B1, B2	M4	1.2 to 1.5 (10.6 to 13.2)	12 to 6	—
			M5	2 to 2.5 (17.7 to 22.1)	14 to 10	10
Series 3	4017	R/L1, S/L2, T/L3, U/T1, V/T2, W/T3, -, +1, +2, B1, B2	M4	1.8 (15.6)	10	12
			M4	1.8 (15.6)	12 to 10	10
Series 4	4018	R/L1, S/L2, T/L3, U/T1, V/T2, W/T3, -, +1, +2	M4	1.2 to 1.5 (10.6 to 13.3)	10 to 6, 12 to 6 (-, +1, +2)	10 to 6
		B1, B2	M4	1.2 to 1.5 (10.6 to 13.3)	12 to 10	—
			M5	2 to 2.5 (17.7 to 22.1)	12 to 10	10
Series 3	4024	R/L1, S/L2, T/L3, U/T1, V/T2, W/T3, -, +1, +2, B1, B2	M5	2.5 (21.99)	10 to 6	10
			M5	2.5 (21.99)	10 to 6	10
Series 4	4024	R/L1, S/L2, T/L3, -, +1, +2	M5	2 to 2.5 (17.7 to 22.1)	8 to 6, 10 to 6 (-, +1, +2)	8 to 6
		U/T1, V/T2, W/T3	M5	2 to 2.5 (17.7 to 22.1)	10 to 6	8 to 6
		B1, B2	M5	2 to 2.5 (17.7 to 22.1)	10 to 8	—
			M6	4 to 6 (35.4 to 53.1)	10 to 8	8
Series 3	4031	R/L1, S/L2, T/L3, U/T1, V/T2, W/T3, -, +1, +2, B1, B2	M5	2.5 (21.99)	8 to 6	8
			M5, M6	2.5 (21.99), 4.0 to 5.0 (35.2 to 43.99)	10 to 6	10
Series 4	4031	R/L1, S/L2, T/L3, U/T1, V/T2, W/T3	M5	2 to 2.5 (17.7 to 22.1)	8 to 6	8 to 6
		-, +1, +2	M5	2 to 2.5 (17.7 to 22.1)	8 to 6	—
		B1, B2	M5	2 to 2.5 (17.7 to 22.1)	10 to 8	—
			M6	4 to 6 (35.4 to 53.1)	10 to 6	6





Product Transition Guide

IMPULSE®•G+ & VG+ Series 4

IMPULSE®•G+ & VG+		Terminal Signal	Terminal Screw	Tightening Torque N. m (lb.in.)	Possible Gauges (AWG/kcmil)	Recommended Gauge (AWG/ kcmil)
Series 3	4039	R/L1, S/L2, T/L3, U/T1, V/T2, W/T3, -, +1, +2	M6	4 to 5 (35.2 to 43.99)	8 to 2	6
		B1, B2	M5	2.5 (21.99)	8	8
			M6	4 to 5 (35.2 to 43.99)	8 to 4	10
Series 4	4039	R/L1, S/L2, T/L3, U/T1, V/T2, W/T3, -, +1, +2	M6	4 to 6 (35.4 to 53.1)	6 to 4	6 to 4
		B1, B2	M5	2 to 2.5 (17.7 to 22.1)	10 to 8	—
			M6	4 to 6 (35.4 to 53.1)	8 to 6	6
Series 3	4045	R/L1, S/L2, T/L3, U/T1, V/T2, W/T3, -, +1, +3, R1/L11, S1/L21, T1/L31	M6	4 to 5 (35.2 to 43.99)	—	6
			M8	9 to 10 (79.2 to 87.97)	—	10
Series 4	4045	R/L1, S/L2, T/L3, U/T1, V/T2, W/T3	M8	9 to 11 (79.7 to 97.4)	6 to 4	6 to 4
		-, +1	M8	9 to 11 (79.7 to 97.4)	6 to 1	—
		B1, B2	M8	9 to 11 (79.7 to 97.4)	8 to 4	—
			M8	9 to 11 (79.7 to 97.4)	8 to 6	6
Series 3	4060	R/L1, S/L2, T/L3, U/T1, V/T2, W/T3, -, +1, +3, R1/L11, S1/L21, T1/L31	M6	4 to 5 (35.2 to 43.99)	—	4
			M8	9 to 10 (79.2 to 87.97)	—	8
Series 4	4060	R/L1, S/L2, T/L3, U/T1, V/T2, W/T3	M8	9 to 11 (79.7 to 97.4)	4 to 3	4 to 2
		-, +1 B1, B2	M8	9 to 11 (79.7 to 97.4)	4 to 1, 6 to 3 (B1, B2)	—
			M8	9 to 11 (79.7 to 97.4)	6	6
Series 3	4075	R/L1, S/L2, T/L3, U/T1, V/T2, W/T3, -, +1, R1/L11, S1/L21, T1/L31	M8	9 to 10 (79.2 to 87.97)	—	2
		+3	M6	4 to 5 (35.2 to 43.99)	—	—
			M8	9 to 10 (79.2 to 87.97)	—	8





Product Transition Guide

IMPULSE®•G+ & VG+ Series 4

IMPULSE®•G+ & VG+		Terminal Signal	Terminal Screw	Tightening Torque N. m (lb.in.)	Possible Gauges (AWG/kcmil)	Recommended Gauge (AWG/ kcmil)
Series 4	4075	R/L1, S/L2, T/L3, U/T1, V/T2, W/T3	M8	9 to 11 (79.7 to 97.4)	3 to 1/0	4 to 2
		-, +1	M8	9 to 11 (79.7 to 97.4)	3 to 1/0	—
		+3	M8	9 to 11 (79.7 to 97.4)	6 to 1/0	—
			M8	9 to 11 (79.7 to 97.4)	6 to 4	4
Series 3	4091	R/L1, S/L2, T/L3, U/T1, V/T2, W/T3, -, +1, R1/L11, S1/L21, T1/L31	M8	9 to 10 (79.2 to 87.97)	—	1
		+3	M6	4 to 5 (35.2 to 43.99)	—	—
			M8	9 to 10 (79.7 to 87.97)	—	6
Series 4	4091	R/L1, S/L2, T/L3, U/T1, V/T2, W/T3	M8	9 to 11 (79.7 to 97.4)	2 to 1/0	2 to 1/0
		-, +1	M8	9 to 11 (79.7 to 97.4)	3 to 1/0	—
		+3	M8	9 to 11 (79.7 to 97.4)	4 to 1/0	—
			M8	9 to 11 (79.7 to 97.4)	6 to 4	4
Series 3	4112	R/L1, S/L2, T/L3, U/T1, V/T2, W/T3, -, +1, R1/L11, S1/L21, T1/L31	M8	9 to 10 (79.2 to 87.97)	—	1/0
		+3	M6	4 to 5 (35.2 to 43.99)	—	—
			M8	9 to 10 (79.2 to 87.97)	—	6
Series 4	4112	R/L1, S/L2, T/L3	M10	18 to 23 (159 to 204)	1/0 to 4/0	1/0 to 2/0
		U/T1, V/T2, W/T3	M10	18 to 23 (159 to 204)	1/0 to 4/0	1/0 to 2/0
		-, +1	M10	18 to 23 (159 to 204)	1/0 to 4/0	—
		+3	M10	18 to 23 (159 to 204)	3 to 4/0	—
			M10	18 to 23 (159 to 204)	4	4

Product Transition Guide

IMPULSE®•G+ & VG+ Series 4

IMPULSE®•G+ & VG+		Terminal Signal	Terminal Screw	Tightening Torque N. m (lb.in.)	Possible Gauges (AWG/kcmil)	Recommended Gauge (AWG/ kcmil)
Series 3	4150	R/L1, S/L2, T/L3, R1/L11, S1/L21, T1/L31, -, +1	M10	17.6 to 22.5 (154.8 to 197.5)	—	3/0
		U/T1, V/T2, W/T3	M10	17.6 to 22.5 (154.8 to 197.5)	—	3/0
		+3	M8	8.8 to 10.8 (77.4 to 95.0)	—	—
			M10	17.6 to 22.5 (154.8 to 197.5)	—	6
		r/ ℓ 1, Δ 200/ ℓ 200, Δ 400/ ℓ 2400	M4	1.3 to 1.4 (11.4 to 12.3)	—	16
Series 4	4150	R/L1, S/L2, T/L3	M10	18 to 23 (159 to 204)	3/0 to 4/0	3/0 to 4/0
		U/T1, V/T2, W/T3	M10	18 to 23 (159 to 204)	3/0 to 4/0	3/0 to 4/0
		-, +1	M10	18 to 23 (159 to 204)	1 to 4/0	—
		+3	M10	18 to 23 (159 to 204)	1/0 to 4/0	—
			M10	18 to 23 (159 to 204)	4 to 2	4
Series 3	4180	R/L1, S/L2, T/L3, -, +1, R1/L11, S1/L21, T1/L31	M10	17.6 to 22.5 (154.8 to 197.5)	—	250 2-2/0
		U/T1, V/T2, W/T3	M10	17.6 to 22.5 (154.8 to 197.5)	—	250 2-2/0
		+3	M8	8.8 to 10.8 (77.4 to 95.0)	—	—
			M10	17.6 to 22.5 (154.8 to 95.0)	—	4
		r/ ℓ 1, Δ 200/ ℓ 200, Δ 400/ ℓ 2400	M4	1.3 to 1.4 (11.4 to 12.3)	—	16
Series 4	4180	R/L1, S/L2, T/L3	M10	18 to 23 (159 to 204)	2 to 300	250 2-2/0
		U/T1, V/T2, W/T3	M10	18 to 23 (159 to 204)	2 to 300	250 2-2/0
		-, +1	M10	18 to 23 (159 to 204)	1 to 250	—
		+3	M10	18 to 23 (159 to 204)	3 to 3/0	—
			M10	18 to 23 (159 to 204)	4 to 300	4





Product Transition Guide

IMPULSE®•G+ & VG+ Series 4

IMPULSE®•G+ & VG+		Terminal Signal	Terminal Screw	Tightening Torque N. m (lb.in.)	Possible Gauges (AWG/kcmil)	Recommended Gauge (AWG/ kcmil)
Series 4	4216	R/L1, S/L2, T/L3	M10	18 to 23 (159 to 204)	—	250 2-2/0
		U/T1, V/T2, W/T3	M10	18 to 23 (159 to 204)	—	250 2-2/0
		-, +1	M10	18 to 23 (159 to 204)	—	—
		+3	M10	18 to 23 (159 to 204)	—	4/0
		⊥	M10	18 to 23 (159 to 204)	—	2
Series 3	4260	R/L1, S/L2, T/L3, -, +1, R1/L11, S1/L21, T1/L31	M10	17.6 to 22.5 (154.8 to 197.5)	—	350 2-3/0
		U/T1, V/T2, W/T3,	M10	17.6 to 22.5 (154.8 to 197.5)	—	350 2-3/0
		+3	M8	8.8 to 10.8 (77.4 to 95.0)	—	—
		⊥	M12	31.4 to 39.2 (276.2 to 344.8)	—	2
		r/ ℓ 1, Δ 200/ ℓ 200, Δ 400/ ℓ 2400	M4	1.3 to 1.4 (11.4 to 12.3)	—	16
Series 4	4260	R/L1, S/L2, T/L3	M12	32 to 40 (283 to 354)	2/0 to 600	350 2-3/0
		U/T1, V/T2, W/T3	M12	32 to 40 (283 to 354)	2/0 to 600	350 2-3/0
		-, +1	M12	32 to 40 (283 to 354)	3/0 to 600	—
		+3	M10	18 to 23 (159 to 204)	1 to 325	—
		⊥	M12	32 to 40 (283 to 354)	2 to 350	2
Series 3	4304	R/L1, S/L2, T/L3, -, +1, R1/L11, S1/L21, T1/L31	M12	31.4 to 39.2 (276.2 to 344.8)	—	350 2-4/0
		U/T1, V/T2, W/T3,	M12	31.4 to 39.2 (276.2 to 344.8)	—	350 2-4/0
		+3	M8	8.8 to 10.8 (77.4 to 95.0)	—	—
		⊥	M12	31.4 to 39.2 (276.2 to 344.8)	—	2
		r/ ℓ 1, Δ 200/ ℓ 200, Δ 400/ ℓ 2400	M4	1.3 to 1.4 (11.4 to 12.3)	—	16

Product Transition Guide

IMPULSE®•G+ & VG+ Series 4

IMPULSE®•G+ & VG+		Terminal Signal	Terminal Screw	Tightening Torque N. m (lb.in.)	Possible Gauges (AWG/kcmil)	Recommended Gauge (AWG/ kcmil)
Series 4	4304	R/L1, S/L2, T/L3	M12	32 to 40 (283 to 354)	3/0 to 600	350 2-4/0
		U/T1, V/T2, W/T3	M12	32 to 40 (283 to 354)	3/0 to 600	350 2-4/0
		-, +1	M12	32 to 40 (283 to 354)	4/0 to 600	—
		+3	M10	18 to 23 (159 to 204)	3/0 to 600	—
			M12	32 to 40 (283 to 354)	1 to 350	1
Series 3	4370	R/L1, S/L2, T/L3	M16	78.4 to 98 (693.9 to 867.4)	—	500 2-250
		U/T1, V/T2, W/T3, R1/L11, S1/L21, T1/L31	M16	78.4 to 98 (693.9 to 867.4)	—	500 2-250
		-, +1	M16	78.4 to 98 (693.9 to 867.4)	—	600×2P
		+3	M16	78.4 to 98 (693.9 to 867.4)	—	—
			M16	78.4 to 98 (693.9 to 867.4)	—	2
		r/ ℓ 1, Δ 200/ ℓ 200, Δ 400/ ℓ 2400	M4	1.3 to 1.4 (11.4 to 12.3)	—	16
Series 4	4370	R/L1, S/L2, T/L3	M12	32 to 40 (283 to 354)	4/0 to 300	500 2-250
		U/T1, V/T2, W/T3	M12	32 to 40 (283 to 354)	4/0 to 300	500 2-250
		-, +1	M12	32 to 40 (283 to 354)	3/0 to 300	—
		+3	M12	32 to 40 (283 to 354)	3/0 to 300	—
			M12	32 to 40 (283 to 354)	1 to 3/0	1
Series 3	4477	R/L1, S/L2, T/L3, R1/L11, S1/L21, T1/L31	M16	78.4 to 98 (693.9 to 867.4)	—	500 2-300 4-3/0
		U/T1, V/T2, W/T3,	M16	78.4 to 98 (693.9 to 867.4)	—	500 2-300 4-3/0
		-, +1	M16	78.4 to 98 (693.9 to 867.4)	—	250×4P
		+3	M16	78.4 to 98 (693.9 to 867.4)	—	—
			M16	78.4 to 98 (693.9 to 867.4)	—	1/0
		r/ ℓ 1, Δ 200/ ℓ 200, Δ 400/ ℓ 2400	M4	1.3 to 1.4 (11.4 to 12.3)	—	16

Product Transition Guide

IMPULSE®•G+ & VG+ Series 4

IMPULSE®•G+ & VG+		Terminal Signal	Terminal Screw	Tightening Torque N. m (lb.in.)	Possible Gauges (AWG/kcmil)	Recommended Gauge (AWG/ kcmil)
Series 4	4450	R/L1, S/L2, T/L3	M12	32 to 40 (283 to 354)	3/0 to 300	500 2-300 4-3/0
		U/T1, V/T2, W/T3	M12	32 to 40 (283 to 354)	3/0 to 300	500 2-300 4-3/0
		-, +1	M12	32 to 40 (283 to 354)	1/0 to 300	—
		+3	M12	32 to 40 (283 to 354)	1/0 to 300	—
		⊥	M12	32 to 40 (283 to 354)	1/0 to 300	1/0
Series 3	4590	R/L1, S/L2, T/L3	M16	78.4 to 98 (693.9 to 867.4)	—	4-250
		R1/L11, S1/L21, T1/L31	M16	78.4 to 98 (693.9 to 867.4)	—	4-250
		U/T1, V/T2, W/T3	M16	78.4 to 98 (693.9 to 867.4)	—	4-250
		-, +1	M16	78.4 to 98 (693.9 to 867.4)	—	400×4P
		+3	M16	78.4 to 98 (693.9 to 867.4)	—	—
		⊥	M16	78.4 to 98 (693.9 to 867.4)	—	1/0
		r/ ℓ 1, Δ 200/ ℓ 200, Δ 400/ ℓ 2400	M4	1.3 to 1.4 (11.4 to 12.3)	—	16
Series 4	4605	R/L1, S/L2, T/L3, U/T1, V/T2, W/T3	M12	32 to 40 (283 to 354)	4/0 to 300	2-400 4-250 4-3/0
		-, +1	M12	32 to 40 (283 to 354)	1/0 to 300	—
		+3	M12	32 to 40 (283 to 354)	1/0 to 300	—
		⊥	M12	32 to 40 (283 to 354)	2/0 to 300	2/0

1.7 Dimensions, Installation Space and Substitution Material

Drive Dimension Comparison

3-Φ 230V Class

Series 3 Model -AFG+ & - FVG+	Series 4 Model -G+S4 & - VG+S4	Outer Dimensions (in)					
		IMPULSE®•G+ & VG+ Series 3			IMPULSE®•G+ & VG+ Series 4		
		W	H	D	W	H	D
N/A	2003	5.51	11.02	6.30	5.51	10.24	5.79
N/A	2005						
2007	2007						
	2008						
2009	2011			7.09			6.46
	2014						
2015	2017						
2023	2025	7.87	11.81	7.87	7.09	11.81	6.57
2031	2033						
2045	2047	9.45	12.20	8.27	8.66	13.78	7.76
2058	2060		13.78				
2071	2075		14.96				
2085	2085	10	21.06	10.24	10.00	15.75	10.16
N/A	2115	10.98	24.21	10.24	10.98	17.72	
2145	2145	14.76	23.62	11.81	12.95	21.65	11.14
N/A	2180			12.99			
2215	2215	17.72	28.54	13.78	17.72	27.76	12.99
2283	2283						
2346	2346	19.69	33.46	14.17	19.69	31.50	13.78

Product Transition Guide

IMPULSE®•G+ & VG+ Series 4

3-Φ 460V Class

Series 3 Model -AFG+ & - FVG+	Series 4 Model -G+S4 & - VG+S4	Outer Dimensions (in)					
		IMPULSE®•G+ & VG+ Series 3			IMPULSE®•G+ & VG+ Series 4		
		W	H	D	W	H	D
N/A	4001	5.51	11.02	6.30	5.51	10.24	5.79
4002	4003						
4003							
4005	4004			7.09			6.46
	4005						
4008	4007 4009						
4012	4014						
4017	4018	7.87	11.81	7.87	7.09	11.81	6.57
4024	4024						
4031	4031	9.45	13.78	8.27	8.66	13.78	7.36
4039	4039			7.76			
4045	4045	10.98	17.72	10.24	10.00	15.75	10.16
4060	4060			10.98			
4075	4075	12.95	21.65	11.22	12.95	20.08	
4091							
--	4091					21.65	11.14
4112	4112	17.72	28.54	13.78	17.95	27.76	12.99
4150	4150						
4180	4180 4216	19.69	33.46	14.17	19.69	31.50	13.78
N/A	4260						
4260							
4304	4304	22.64	36.06	14.88	26.38	44.88	14.57
4370	4370	27.95	51.38	16.26			
4477	4450						
4590	4605	36.06	58.07				

Product Transition Guide

IMPULSE®•G+ & VG+ Series 4

IMPULSE®•G+/VG+ Series 4 Drive Options

Category	Option Name	Model Number
Network Communication	Profibus-DP	SI-P3
	EtherNet/IP	SI-EN3
	Modbus TCP/IP	SI-EM3
	DeviceNET	SI-N3
Motor Feedback	Line Driver PG	PG-X3
	Open Collector PG	PG-B3
Input/Output	Analog Input	AI-A3
	Analog Output	AO-A3
	Digital Input	DI-A3
	Digital Output	DO-A3
	Digital Input	S4I-120A60
Control Power Unit	24 V Control Power Unit	PS-A10H for 480 V and 600 V class PS-A10L for 240 V class
Parameter Management	Y-Stick USB Copy Unit	JVOP-181
Operator	LCD Operator	JVOP-180
Remote Keypad Mounting Kit	LCD Operator Remote Mount Kit	S4-RMT-OPER-KIT

Product Transition Guide

IMPULSE®•G+ & VG+ Series 4

IMPULSE®•G+ Series 3 Wiring Diagram

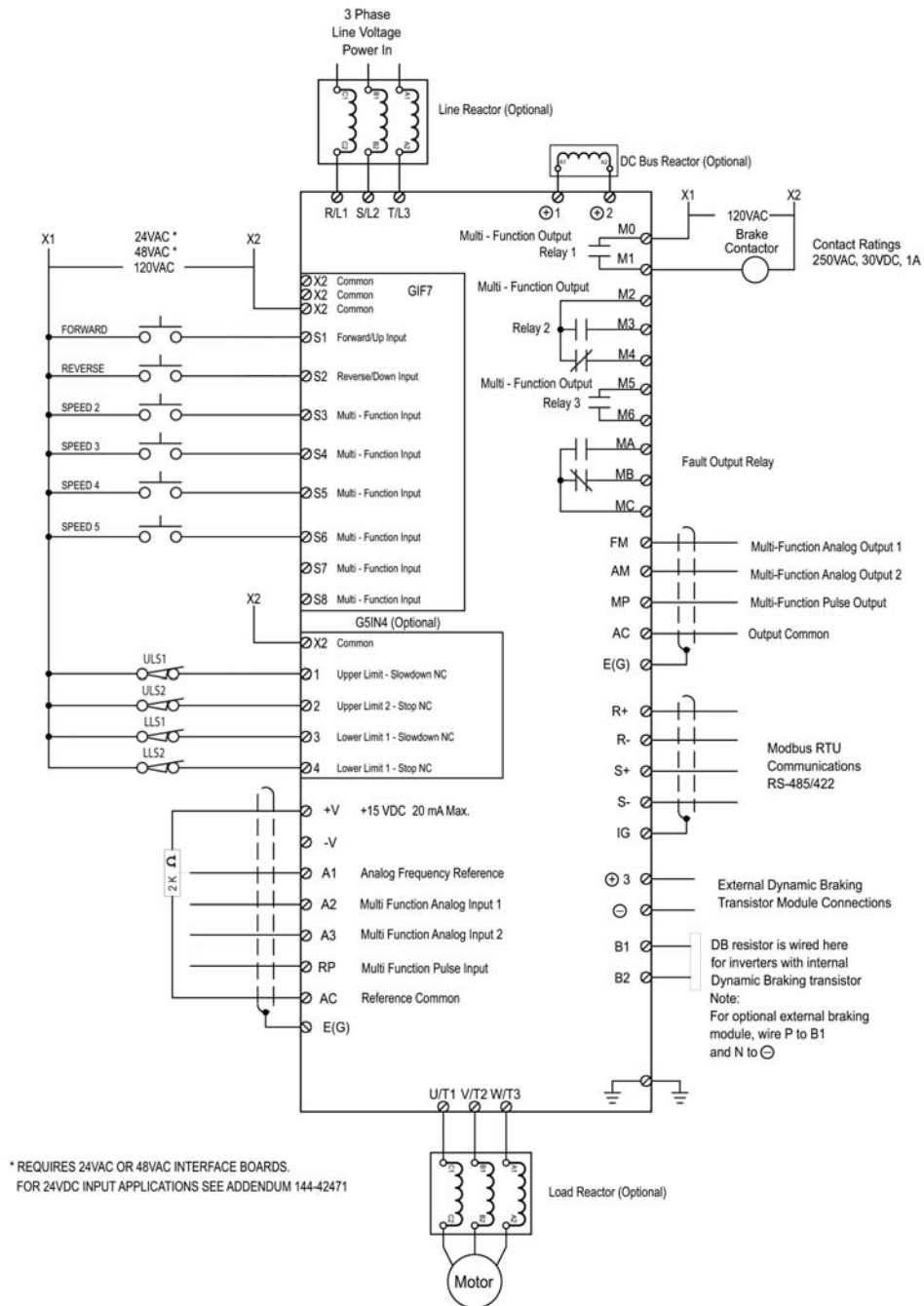

Product Transition Guide IMPULSE®•G+ & VG+ Series 4

IMPULSE®•VG+ Series 3 Wiring Diagram

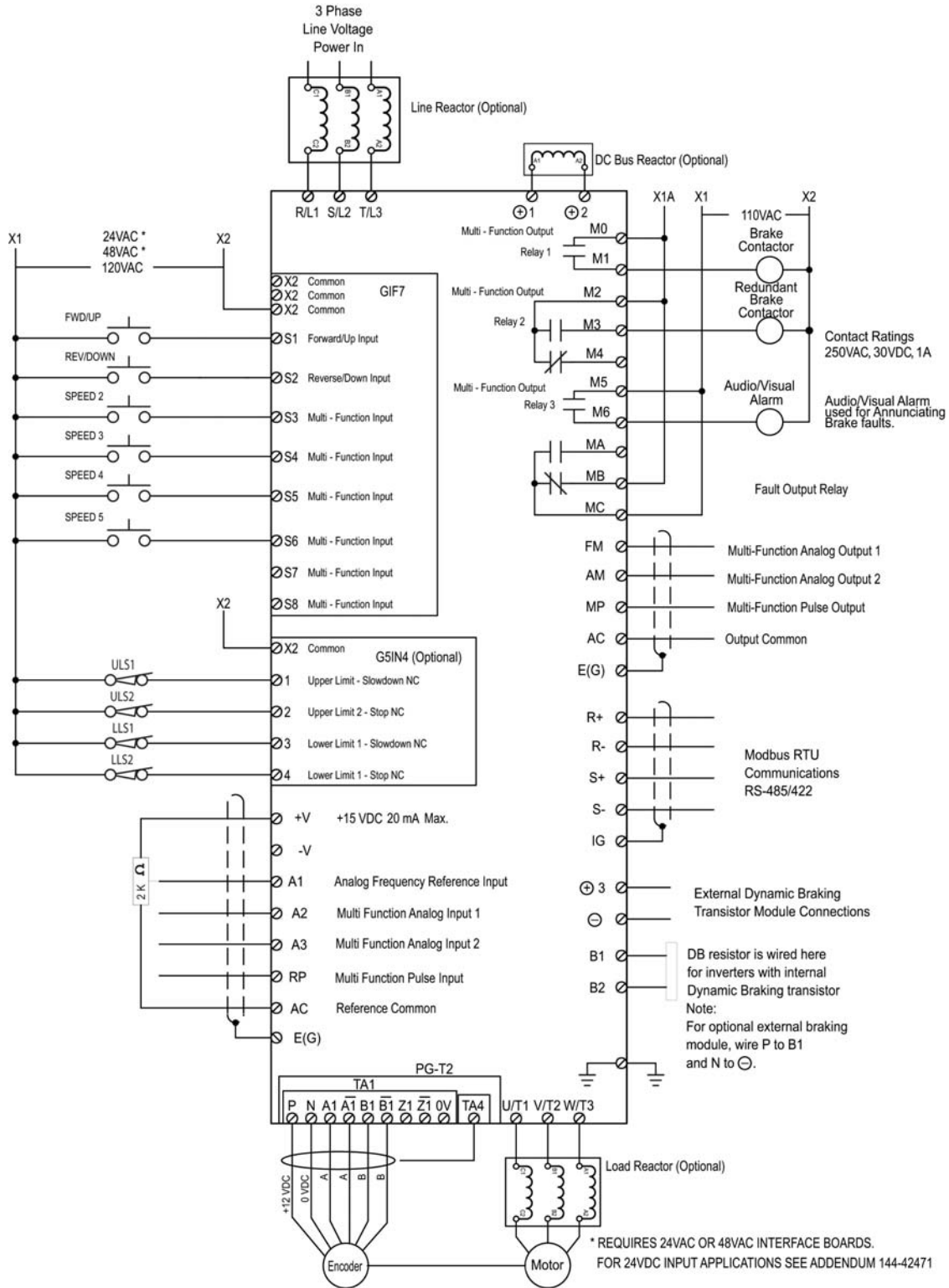

Product Transition Guide

IMPULSE®•G+ & VG+ Series 4

IMPULSE®•G+/VG+ Series 4 Wiring Diagram

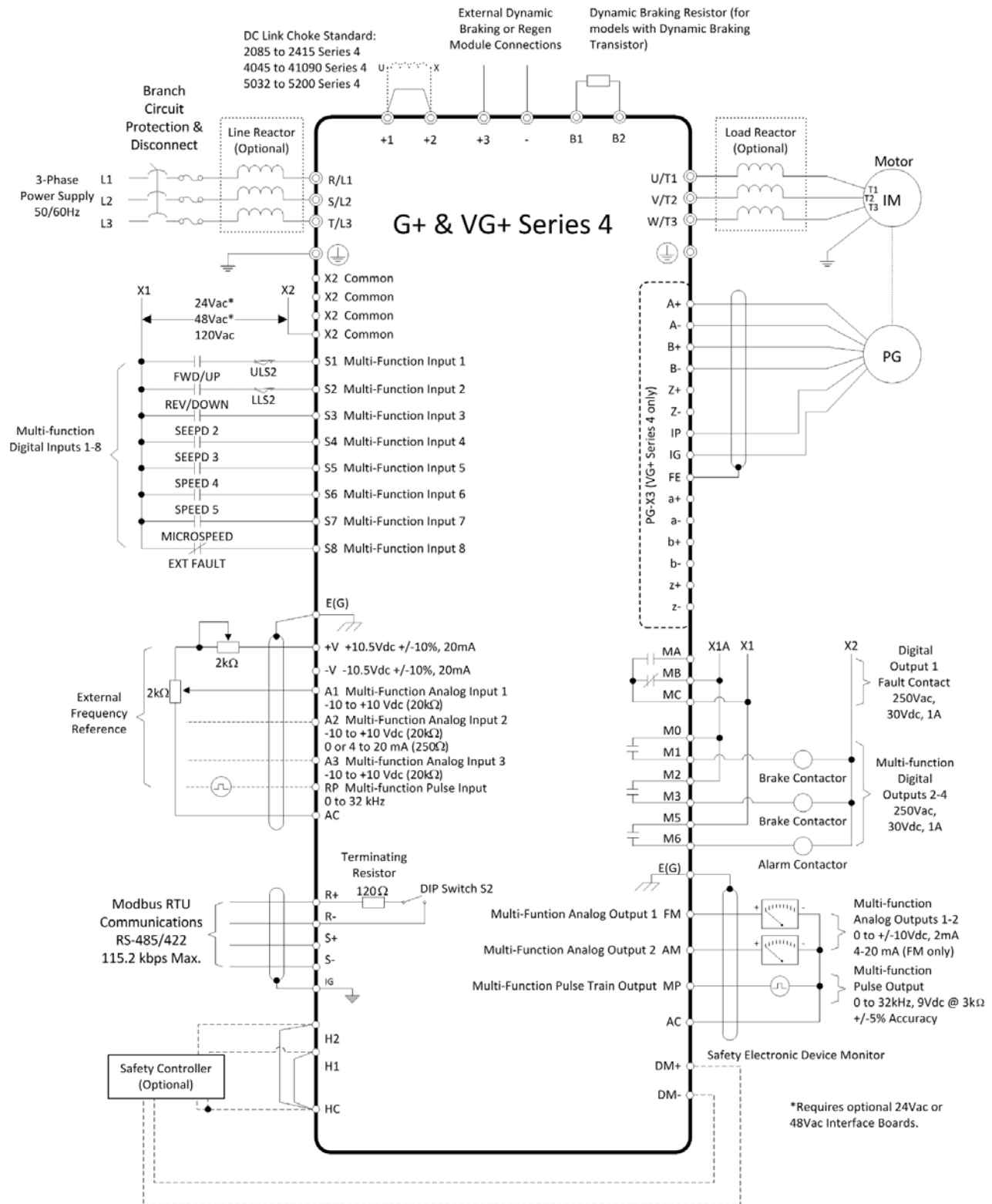

1.8 Parameter Cross Reference

Parameter Name	Series 3		Series 4		Comments	
	No.	Default	No.	Default	Series 3	Series 4
Language Selection	A1-00	0	A1-00	0	0: English	0: English
					1: French	--
					2: Spanish	--
Parameter Access Level	A1-01	2	A1-01	2	0: Operation Only	0: Operation Only
					1: User Parameters	1: User Parameters
					2: Advanced Level	2: Advanced Level
Control Method Selection	A1-02	G+: 0 VG+: 3	A1-02	G+: 0 VG+: 3	0: V/f Control (G+ only)	0: V/f Control for Induction Motors
					2: Open Loop Vector (G+ only)	2: Open Loop Vector Control
					3: Flux Vector (VG+ only)	3: Closed Loop Vector Control
Select Motion	A1-03	G+: 1 VG+: 2	A1-03	G+: 1 VG+: 2	0: Traverse	0: Traverse
					1: Standard Hoist	1: Standard Hoist
					2: No-Load Brake Hoist	2: Hoist NLB
					--	4: Braketronic
Speed Reference	A1-04	6	A1-04	1	0: 5-SPD Multi-step	0: 2-SPD Multi-step
					1: 2-Step infinitely variabl	1: 3-SPD multi-step
					2: 3-Step infinitely variable	2: 5-SPD Multi-step
					3: Uni-polar analog	3: 2-Step infinitely variable
					4: Bi-polar analog	4: 3-Step infinitely variabl
					5: 2-SPD Multi-step	5: Uni-polar analog
					6: 3-SPD multi-step	6: Bi-polar analog
					7: Not Used	7: Digital Opt Card
Initial Parameters	A1-05	0	A1-05	0	0: No Initialization	0: No Initialization
					1110: User Initialization	1110: User Initialize
					--	2220: 2-Wire Initialization
					--	5550: OPE04 Reset
					--	9990: EEPROM
Password Entry	A1-06	0000	A1-06	0000	Range: 0000 ~ 9999	
Seelct Password	A1-07	0000	A1-07	0000	Range: 0000 ~ 9999	
Enter Password	A1-08	0000	A1-08	0000	Range: 0000 ~ 9999	
User Parameters	A2-01 ~ A2-30	--	A2-01 ~ A2-30	--	--	
Reference 1	B1-01	15.00 Hz	B1-01	15.00 Hz	--	
Reference 2	B1-02	30.00 Hz	B1-02	30.00 Hz	--	

Product Transition Guide

IMPULSE®•G+ & VG+ Series 4

Parameter Name	Series 3		Series 4		Comments	
	No.	Default	No.	Default	Series 3	Series 4
Reference 3	B1-03	60.00 Hz	B1-03	60.00 Hz	--	
Reference 4	B1-04	0.00 Hz	B1-04	0.00 Hz	--	
Reference 5	B1-05	0.00 Hz	B1-05	0.00 Hz	--	
Reference 6	B1-06	0.00 Hz	B1-06	0.00 Hz	--	
Reference 7	B1-07	0.00 Hz	B1-07	0.00 Hz	--	
Reference 8	B1-08	0.00 Hz	B1-08	0.00 Hz	--	
Reference 9	B1-09	0.00 Hz	B1-09	0.00 Hz	--	
Reference 10	B1-10	0.00 Hz	B1-10	0.00 Hz	--	
Reference 11	B1-11	0.00 Hz	B1-11	0.00 Hz	--	
Reference 12	B1-12	0.00 Hz	B1-12	0.00 Hz	--	
Reference 13	B1-13	0.00 Hz	B1-13	0.00 Hz	--	
Reference 14	B1-14	0.00 Hz	B1-14	0.00 Hz	--	
Reference 15	B1-15	0.00 Hz	B1-15	0.00 Hz	--	
Reference 16	B1-16	0.00 Hz	B1-16	0.00 Hz	--	
Jog Reference	B1-17	6 Hz	B1-17	6.00 Hz	--	
Ref Priority	B1-18	0	B1-18	0	0: Digital Ref Only 1: Analog Ref Only 2: Higher Ref Sel	0: Digital Ref Only 1: Analog Ref Only 2: Higher Ref Sel
Ref Upper Limit	B2-01	100.0%	B2-01	100.0%	--	
Ref Lower Limit	B2-02	2.0%	B2-02	0.0%	--	
Ref 1 Lower Limit	B2-03	G+: 2.0% VG+: 0.0%	B2-03	G+: 2.0% VG+: 0.0%*	*Initial value set by X-Press programming.	
Alt Upper Limit	B2-04	100.0%	B2-04	0.0%	--	
Reference Source	B3-01	1	B3-01	1	0: Operator	0: Operator
					1: Terminals	1: Terminals
					2: Serial Com	2: Communication
					3: Option PCB	3: Option PCB
					4: Pulse Input (H6-01)	4: Pulse Input (H6-01)
Run Source	B3-02	1	B3-02	1	0: Operator	0: Operator
					1: Terminals	1: Terminals
					2: Communication	2: Communication
					3: Option PCB	3: Option PCB
Stop Method	B3-03	G+: 1 VG+: 6	B3-03	G+: 1 VG+: 6	0: Decel to Stop (A1-03=0)	0: Decel to Stop
					1: Coast to Stop (A1-03=1)	1: Coast to Stop
					2: DC Injection to Stop (G+ only)	--
					4: Decel with timer (Traverse mode only)	4: Decel with timer (Traverse mode only)
					6: No Load Brake (A1-03=2) (VG+ only)	6: No Load Brake (See No-Load Brake Start/Stop)
Reverse Oper	B3-04	0	B3-04	0	0: Normal Rotation	0: Standard
					1: Exchange Phases	1: SwitchPhase Order

Product Transition Guide

IMPULSE®•G+ & VG+ Series 4

Parameter Name	Series 3		Series 4		Comments	
	No.	Default	No.	Default	Series 3	Series 4
Zero-Speed Oper	B3-05 (VG+ only)	0	B3-05 (VG+ only)	0	0: RUN at Freq Ref	0: RUN at Freq Ref
					1: Stop	1: STOP
					2: RUN at Min. Freq (E1-09)	2: RUN at Min. Freq (E1-09)
					3: RUN at Zero RPM	3: RUN at Zero RPM
# of Input Scans	B3-06	1	B3-06	1	0: 2ms–2 scans	0: 1 scan (1 ms)
					1: 5ms–2 scans	1: 2 scans (2 ms)
LOC/REM Run Sel	B3-07	0	B3-07	0	0: Cycle Extrn Run	0: Cycle Extrn Run
					1: Accep Extrn Run	1: Accep Extrn Run
Run Command at Program	B3-08	0	B3-08	0	0: Disabled	0: Disabled
					1: Enabled	1: Enabled (B3-02=0 is Disabled)
Allow Run at Power UP	B3-10	0	B3-10	0	0: Disabled	0: Cycle Ext Run
					1: Enabled	1: Accept Ext Run
MOP Ref Memory	B4-01	0	--	--	0: Disabled	--
					1: Enabled	--
Trim Control LVL	B4-02	10%	--	--	--	--
Accel Time 1	B5-01	5.0 sec	B5-01	5.0 sec	--	--
Decel Time 1	B5-02	3.0 sec	B5-02	3.0 sec	--	--
Accel Time 2	B5-03	2.0 sec	B5-03	10.0 sec	--	--
Decel Time 2	B5-04	2.0 sec	B5-04	10.0 sec	--	--
Accel Time N Chg	B5-05	2.0 sec	B5-05	2.0 sec	--	--
Dec Time N Chg	B5-06	2.0 sec	B5-06	2.0 sec	--	--
Fast Stop Time	B5-08	0.5 sec	B5-08	0.5 sec	--	--
Acc/Dec Units	B5-09	1	B5-09	1	0: 0.01sec for 0.00–2.55 sec	0: 0.01sec for 0.00–2.55 sec
					1: 0.1sec for 0.0–25.5 sec	1: 0.1sec for 0.0–25.5 sec
Acc/Dec SW Freq	B5-10	120.0 Hz	B5-10	0.0 Hz	--	--
SW Freq Compare	B5-11	1	B5-11	1	0: Lower SW Freq	0: Lower SW Freq
					1: Upper SW Freq	1: Upper SW Freq
Accel Time 3	B5-12	3.0 sec	B5-12	3.0 sec	--	--
Decel Time 3	B5-13	3.0 sec	B5-13	3.0 sec	--	--
Accel Time 4	B5-14	3.0 sec	B5-14	3.0 sec	--	--
Decel Time 4	B5-15	3.0 sec	B5-15	3.0 sec	--	--

Product Transition Guide

IMPULSE®•G+ & VG+ Series 4

Parameter Name	Series 3		Series 4		Comments	
	No.	Default	No.	Default	Series 3	Series 4
Spd Srch at Start	B6-01 (G+ only)	2			0: Speed Search (Estimated) Disabled	
					1: Speed Search (Estimated) Enabled	
					2: Speed Search (Current Detect) Disabled	
					3: Speed Search (Current Detect) Enabled	
Spd Srch Current	B6-02 (G+ only)	120%	--	--	--	--
Spd Srch Dec Time	B6-03 (G+ only)	2.0 sec	--	--	--	--
Search Delay	B6-05	120%	--	--	--	--
Jump Freq 1	B8-01	0.0 Hz	B8-01	0.0 Hz	--	--
Jump Freq 2	B8-02	0.0 Hz	B8-02	0.0 Hz	--	--
Jump Freq 3	B8-03	0.0 Hz	B8-03	0.0 Hz	--	--
Jump Bandwidth	B8-04	1.0 Hz	B8-04	1.0 Hz	--	--
Quick Stop 0/1	C1-01	G+: 0 VG+: 1	C1-01	G+: 0 VG+: 1	0: Disabled 1: Enabled	0: Disabled 1: Enabled
Quick Stop Time	C1-02	1.0 sec	C1-02	1.0 sec	--	--
Reverse Plug 0/1	C1-03	0	C1-03	0	0: Disabled 1: Enabled	0: Disabled 1: Enabled
Rev-Plg Dec Time	C1-04	2.0 sec	C1-04	2.0 sec	--	--
Rev-Plg Acc Time	C1-05	2.0 sec	C1-05	2.0 sec	--	--
MicroSpd Gain 1	C2-01	1.00	C2-01	1.00	--	--
MicroSpd Gain 2	C2-02	1.00	C2-02	1.00	--	--
Up Limit 1 Speed	C3-01	6 Hz	C3-01	6.00 Hz	--	--
UL 1 Decel Time	C3-02	1.0 sec	C3-02	1.0 sec	--	--
UL 2 Stop Time	C3-03	1.0 sec	C3-03	1.0 sec	--	--
Low Limit 1 Speed	C3-04	6 Hz	C3-04	6.00 Hz	--	--
LL 1 Decel Time	C3-05	1.0 sec	C3-05	1.0 sec	--	--
LL 2 Stop Time	C3-06	1.0 sec	C3-06	1.0 sec	--	--
Lmt Stop Method	C3-07	2	C3-07	2	0: Decel to Stop 1: Coast to Stop 2: Use B3-03 Method	0: Decel to Stop 1: Coast to Stop 2: Use B3-03 Method

Product Transition Guide

IMPULSE®•G+ & VG+ Series 4

Parameter Name	Series 3		Series 4		Comments	
	No.	Default	No.	Default	Series 3	Series 4
UL3 Stop Method	C3-08	4	C3-08	4	0: Decel/Alarm (no further raise allowed)	0: Decel/Alarm
					1: Coast/Alarm (no further raise allowed)	1: Coast/Alarm
					2: Use B3-03 /Alarm (no further raise allowed)	2: Use B3-03/ Alarm
					3: Decel/Fault	3: Decel/Fault
					4: Coast/Fault	4: Coast/Fault
					5: Use B3-03/Fault	5: Use B3-03/Fault
					For setting 0, 2, 3, 5, deceleration is by B5-08.	For setting 0, 2, 3, 5, deceleration is by B5-08.
Phantom Stop Method	C3-09	1	C3-10	1	0: Decel to Stop	0: Decel to Stop
					1: Coast to Stop	1: Coast to Stop
					2: Use B3-03 Method	2: Use B3-03 Method
Load Share Lim	C3-10 (VG+ only)	0	C3-11 (VG+ only)	1	0: Disabled	0: Disabled
					1: Enabled	1: Enabled
Klixon Action	C3-11	0	C3-12	0	0: Use B3-03 Method	0: Use B3-03 Method
					1: Allow Lower Only	1: Allow Lower Only
UL2 Revolutions	C3-12 (VG+ only)	0 Revs	C3-16 (VG+ only)	0 Revs		--
UL1 Revolutions	C3-13 (VG+ only)	0 Revs	C3-17 (VG+ only)	0 Revs		--
LL1 Revolutions	C3-14 (VG+ only)	0 Revs	C3-18 (VG+ only)	0 Revs		--
LL2 Revolutions	C3-15 (VG+ only)	0 Revs	C3-19 (VG+ only)	0 Revs		--
Load Float Time 2	C4-01 (VG+ only)	10 sec	C4-01 (VG+ only)	10 sec		--
Load Float Gain	C4-02 (VG+ only)	Drive Dependent	C4-02 (VG+ only)	5		--
Load Float Count	C4-03 (VG+ only)	10	C4-03 (VG+ only)	10		--
Load Check 0/1	C5-01	0	C5-01	0	0: Disabled	0: Disabled
					1: Enabled	1: Hold & Measure
					--	3: Immediate
					--	9: Setup
LC Alarm Action	C5-02	4	C5-02	4	0: Alarm Only	0: Alarm Only
					1: Decel to Stop	1: Decel to Stop
					2: Coast to Stop	2: Coast to Stop
					3: Fault Stop	3: Fault Stop
					4: Use B3-03 Method (allows Lower only)	4: Use B3-03 Method (allows Lower only) (alarm)

Product Transition Guide

IMPULSE®•G+ & VG+ Series 4

Parameter Name	Series 3		Series 4		Comments	
	No.	Default	No.	Default	Series 3	Series 4
Min Torque Ref	C5-03	60%	C5-03	60%	--	
Look Speed 1	C5-04	6 Hz	--	--	--	
Look Speed 2	C5-07	20 Hz	--	--	--	
I/T Ref for LS 2	C5-08	160%	--	--	--	
Look Speed 3	C5-09	40 Hz	--	--	--	
I/T Ref for LS 3	C5-10	160%	--	--	--	
I Ref for > LS 3	C5-11	160%	--	--	--	
LC Holding Time	C5-12	1.00 sec	--	--	--	
LC Testing Time	C5-13	0.25 sec	C5-13	0.25 Hz	--	
LC Fault Speed	C5-14	6 Hz	C5-14	6 Hz	--	
Swift Lift 0/1 (G+S3) Ultra Lift 0/1 (VG+S3)	C6-01	0	C6-01	0	0: Disabled 1: Enabled Automatic 2: Enabled by MFI = 13 -- --	0: Disabled 1: Enabled Auto 2: Enabled by MFDI 3: Enabled Adaptive 4: Adaptive by MFDI
Swift Lift ForSpd (G+S3) Ultra Lift ForSpd (VG+S3)	C6-02	60 Hz	C6-02	60 Hz	--	
Swift Lift RevSpd (G+S3) Ultra Lift RevSpd (VG+S3)	C6-03	60 Hz	C6-03	60 Hz	--	
SL Fwd Torque (G+S3) UL Fwd Torque (VG+S3)	C6-04	50%	C6-04	50%	--	
SL Rev Torque (G+S3) UL Rev Torque (VG+S3)	C6-05	30%	C6-05	30%	--	
UL Enabling Spd	C6-06	59 Hz	C6-06	59 Hz	--	
UL Delay Time	C6-07	2.0 sec	C6-07	2.0 sec	--	
SFS Acc Gain	C6-08	1.0	C6-08	1.0	--	
Normal OS Level	C6-09 (VG+ only)	60 Hz	--	--	--	
Torq Limit Fwd	C7-01	150%	C7-01	150%	--	
Torq Limit Rev	C7-02	150%	C7-02	150%	--	
Torq Lmt Fwd Rgn	C7-03	180%	C7-03	180%	--	
Torq Limit Rev Rgn	C7-04	180%	C7-04	180%	--	
Torq Limit Gain	C7-07	1.25	--	--	--	
Trav Trq Limiter	C7-08 (VG+ only)	0	C7-10	0	0: Disabled 1: Enabled	0: Disabled 1: Enabled
Limiter Freq	C7-09 (VG+ only)	2.0	C7-11	2.0	--	

Product Transition Guide

IMPULSE®•G+ & VG+ Series 4

Parameter Name	Series 3		Series 4		Comments	
	No.	Default	No.	Default	Series 3	Series 4
Torque Comp Time	C8-01 (VG+ only)	Determined by Drive	C8-01 (VG+ only)	1.0/1.5 sec	--	
IFB OK Timer	C8-02 (VG+ only)	Determined by Drive	C8-02 (VG+ only)	1.0/1.5 sec	--	
Min Brk Rel Torq	C8-03 (VG+ only)	10%	C8-03 (VG+ only)	10%	--	
Roll Back Timer	C8-04	0.3 sec	C8-04 (VG+ only)	0.3 sec	--	
Roll Back Count	C8-05 (VG+ only)	800 pulses	C8-05 (VG+ only)	800 pulses	--	
BE3/Alt Torq T	C8-06 (VG+ only)	0.30 sec	C8-06 (VG+ only)	0.30 sec	--	
BE3 Det Count	C8-07 (VG+ only)	10 pulses	C8-07 (VG+ only)	10 pulses	--	
Alt Rev Torq Lim	C8-08 (VG+ only)	25%	C8-08 (VG+ only)	25%	--	
Zero Speed Level	C8-09 (VG+ only)	1 Hz	C8-09 (VG+ only)	1 Hz	--	
Load Float Time	C8-10 (VG+ only)	10 sec	C8-10 (VG+ only)	10 sec	--	
Brake Set Delay	C8-11	0.7 sec	C8-11 (VG+ only)	0.7 sec	--	
BE6 Detect Timer	C8-12 (VG+ only)	5.0 sec	C8-12 (VG+ only)	5.0 sec	--	
BE6 Max Count	C8-13 (VG+ only)	250 pulses	C8-13 (VG+ only)	250 pulses	--	
Brake Hold Speed	C8-14 (VG+ only)	0.0%	C8-14 (VG+ only)	5.0 (OLV) 0.0 (FLV)	--	
Load Float Ext. T	C8-15 (VG+ only)	10 sec	C8-15 (VG+ only)	10 sec	--	
Init Brk Rel Trq	C8-16 (VG+ only)	100%	--	--	--	
BE6 Up Speed	C8-17 (VG+ only)	6.00 Hz	C8-18 (VG+ only)	6.00 Hz	--	
Brake Test Torq	C8-19 (VG+ only)	125%	C8-24 (VG+ only)	125%	--	
Brake Test Speed	C8-20 (VG+ only)	6 Hz	C8-20 (VG+ only)	6 Hz	--	
Height Measure	C8-21 (VG+ only)	10000 pulses	C3-13 (VG+ only)	250	--	
Hook Height Home	C8-24 (VG+ only)	0	C3-14 (VG+ only)	0	0: Home = UL2	0: Home = UL2
					1: Home = LL2	1: Home = LL2
					2: Home = Hook Height Home	2: Home MFDI Upper
					--	3: Home MFDI Lower
					4: Home = UL3	4: Home = UL3

Product Transition Guide

IMPULSE®•G+ & VG+ Series 4

Parameter Name	Series 3		Series 4		Comments	
	No.	Default	No.	Default	Series 3	Series 4
Hook Height Out	C8-25 (VG+ only)	0	C3-15 (VG+ only)	0	0: At Home = 0V - U1-50 = 0%, MFAO = 0V 1: At Home = 10V - U1-50 = 100%, MFAO = 10V	0: At Home 0% - U1-50 = 0%, MFAO = 0V 1: At Home 100% - U1-50 = 0%, MFAO = 0V
Load Float Fault Revolutions	C8-26 (VG+ only)	4 Revs	--	--	--	--
Digital In Setup	C9-01	0	C9-01	0	0: Disabled 1: G5IN4/C9-02 2: G5IN4/C9-03 - 06 3: DI-08/C9-03 - 10 DI-08 8 CH Individual 4: DI-16/C9-03 - 12 DI-16 Terminals 10 CH Individual 5: Serial/C9-03 - 12 10 CH Individual	0: Disabled 1: Enabled 2: Serial -- -- --
G5IN4 Setup	C9-02	0	C9-02	0F	--	--
DIO Terminal 1	C9-03	0F	C9-03	0F	--	--
DIO Terminal 2	C9-04	0F	C9-04	0F	--	--
DIO Terminal 3	C9-05	0F	C9-05	0F	--	--
DIO Terminal 4	C9-06	0F	C9-06	0F	--	--
DIO Terminal 5	C9-07	0F	C9-07	0F	--	--
DIO Terminal 6	C9-08	0F	C9-08	0F	--	--
DIO Terminal 7	C9-09	0F	C9-09	0F	--	--
DIO Terminal 8	C9-10	0F	C9-10	0F	--	--
DIO Terminal 9	C9-11	0F	C9-11	0F	--	--
DIO Terminal 10	C9-12	0F	C9-12	0F	--	--
Load Weight 0/1	C10-01	0	C10-01	0	0: Disabled 1: Enabled at C5- 04 (Automatic for the duration of C5- 12 + C5-13) (VG+ only) 2: Enabled at MFI=5C (VG+ only) 3: Both Auto & MFI=5C (VG+ only) 4: Analog Input (Load Cell) MFAI=16	0: Disabled 1: Enabled (FVC Only) 2: Enabled Analog -- --
Torque Pri Delay	C10-02 (VG+ only)	200ms	--	--	--	--
LW Display Hold	C10-03	0	C10-03	0	0: Hold Display 1: Hold Disp 3 sec	0: Hold Display 1: Hold Disp 3 sec
LW Conversion	C10-04 (VG+ only)	0	C10-04 (VG+ only)	00000	--	--

Product Transition Guide

IMPULSE®•G+ & VG+ Series 4

Parameter Name	Series 3		Series 4		Comments	
	No.	Default	No.	Default	Series 3	Series 4
Full Load Torque	C10-05 (VG+ only)	100.0%	C10-09 (VG+ only)	100.0%	--	
No Load Torque	C10-06 (VG+ only)	20.0%	C10-10 (VG+ only)	20.0%	--	
Unit Displayed	C10-07 (VG+ only)	0	C10-06 (VG+ only)	0	0: tons	0: Tons
					1: pounds	1: Pounds
					2: kilograms	2: Kilograms
					3: metric tons	3: Metric Tons
					4: percent load	4: Percent Load
Weight Limit Output	C10-08	125%	--	--	--	
Slack Cable 0/1	C11-01 (VG+ only)	0	C11-01 (VG+ only)	0	0: Disabled	0: Disabled
					1: Enabled	1: Enabled
Action at SLC	C11-02 (VG+ only)	2	C11-02 (VG+ only)	2	0: No Action	0: No Action
					1: No Act/C3-04	1: No Act/C3-04
					2: Decel/C3-04	2: Decel/C3-04
					3: Decel/No Opr	3: Decel/No Opr
					4: Dec Stop/C3-04	4: Dec Stop/C3-04
5: Dec Stop/No Opr	5: Dec Stop/No Opr					
SLC Detect Torq	C11-03 (VG+ only)	30%	C11-03 (VG+ only)	30%	--	
SLC Detect Spd 1	C11-04 (VG+ only)	2 Hz	C11-04 (VG+ only)	2 Hz	--	
SLC Delay Time 1	C11-05 (VG+ only)	0.50 sec	C11-05 (VG+ only)	0.50 sec	--	
SLC Detect Spd 2	C11-06 (VG+ only)	60 Hz	C11-06 (VG+ only)	60 Hz	--	
SLC Delay Time 2	C11-07 (VG+ only)	0.10 sec	C11-07 (VG+ only)	0.10 sec	--	
Snap Shaft 0/1	C11-08 (VG+ only)	0	C11-08 (VG+ only)	0	0: Disabled	0: Disabled
					1: Enabled	1: Enabled
Action at Snap	C11-09 (VG+ only)	0	C11-09 (VG+ only)	0	0: Brake/fault out	0: Brake/fault out
					1: Alarm Only	1: Alarm Only
SS Delta speed	C11-10 (VG+ only)	1.0 Hz	C11-10 (VG+ only)	1.0 Hz	--	
SS Delay Time	C11-11 (VG+ only)	250 ms	C11-11 (VG+ only)	250 ms	--	
SS Gear Ratio Num	C11-12 (VG+ only)	10000	C11-12 (VG+ only)	10000	--	
SS Gear Ratio Den	C11-13 (VG+ only)	10000	C11-13 (VG+ only)	10000	--	
Brake Jog Delay	C12-01	0.0 sec	C12-01	0.0 sec	--	
Brake Run Delay	C12-02	0.0 sec	C12-02	0.0 sec	--	
Delay-on timer	C12-03	0.0	C12-03	0.0 sec	--	
Delay-off timer	C12-04	0.0	C12-04	0.0 sec	--	
Maintenance Tmr	C12-05	0	C12-05	0	--	
Maintenance Gain	C12-06	0.5	C12-06	0.5	--	
Inch Run Time	C13-01	1.00 sec	C13-01	1.00 sec	--	

Product Transition Guide

IMPULSE®•G+ & VG+ Series 4

Parameter Name	Series 3		Series 4		Comments	
	No.	Default	No.	Default	Series 3	Series 4
Repeat Delay T	C13-02	1.00 sec	C13-02	1.00 sec	--	
Index Run Ref	C13-03 (VG+ only)	0.10 Hz	C13-03 (VG+ only)	0.10 Hz	--	
Index Revs	C13-04 (VG+ only)	0 Revs	C13-04 (VG+ only)	0 Revs	--	
Index Count	C13-05 (VG+ only)	100 pulses	C13-05 (VG+ only)	100 pulses	--	
Index Rpt Delay	C13-06 (VG+ only)	0.00 sec	C13-06 (VG+ only)	0.00 sec	--	
Index Complete	C13-07 (VG+ only)	10	C13-07 (VG+ only)	10	--	
Index Zsv Gain	C13-08 (VG+ only)	10	C13-08 (VG+ only)	10	--	
Index ASR P Gain	C13-09 (VG+ only)	30	C13-09 (VG+ only)	30.00	--	
Index ASR I Time	C13-10 (VG+ only)	0.02 sec	C13-10 (VG+ only)	0.200 sec	--	
Acc/Dec Gain	C13-11 (VG+ only)	5.0	C13-11 (VG+ only)	1.0	--	
Index Brake Ctrl	C13-12 (VG+ only)	0	C13-12 (VG+ only)	NLB: 2 else: 0	0: Open on Index Command	0: Open on Index Command
					1: Open on Each Run	1: Open on Each Run
					2: Latch Open on Run	2: Latch Open on Run
DCInj Start Freq	D1-01	0.5 Hz	D1-01	0.5 Hz	--	
DCInj Current	D1-02 (G+ only)	50%	D1-02 (G+ only)	50%	--	
DCInj@Start	D1-03	0.00 sec	D1-03	0.00 sec	--	
DCInj Time@Stop	D1-04	0.05 sec	D1-04	0.05 sec	--	
Slip Comp Gain	D2-01	1.0 (OLV) 0 (V/F)	D2-01	0.0 V/f 1.0 OLV 1.0 FLA	--	
Slip Comp Time	D2-02 (G+ only)	200 (OLV) 2000 (V/F)	D2-02 (G+ only)	A1-02 2000 V/F 200 OLV	--	
Slip Comp Limit	D2-03 (G+ only)	200%	D2-03 (G+ only)	200%	--	
Slip Comp Regen	D2-04 (G+ only)	0	D2-04 (G+ only)	0	0: Disabled	0: Disabled
					1: Enabled	1: Enabled >6 Hz in regen
					--	2: Enabled >D2-07 in regen.
Slip Comp V/F	D2-05	0	D2-05 (VG+ only)	0	0: Include	0: Disabled
					1: Exclude	1: Enabled
Torq Comp Gain	D3-01 (G+ only)	1.00	D3-01 (G+ only)	1.00	--	
Torq Comp Time	D3-02 (G+ only)	20 ms(OLV) 200 ms (V/F)	D3-02 (G+ only)	20 ms(OLV) 200 ms (V/F)	--	
F TorqCmp @ Start	D3-03 (G+ only)	0.0%	D3-03 (G+ only)	0.0%	--	

Product Transition Guide

IMPULSE®•G+ & VG+ Series 4

Parameter Name	Series 3		Series 4		Comments	
	No.	Default	No.	Default	Series 3	Series 4
R TorqCmp @ Start	D3-04 (G+ only)	0.0%	D3-04 (G+ only)	0.0%	--	
TorqCmp Delay T	D3-05 (G+ only)	10 ms	D3-05 (G+ only)	10 ms	--	
ASR P Gain 1	D4-01 (VG+ only)	30	D4-01 (VG+ only)	30.00	--	
ASR 1 Time 1	D4-02 (VG+ only)	0.500 sec	D4-02 (VG+ only)	0.500 sec	--	
ASR P Gain 2	D4-03 (VG+ only)	30	D4-03 (VG+ only)	A1-02	--	
ASR 1 Time 2	D4-04 (VG+ only)	0.100 sec	D4-04 (VG+ only)	A1-02	--	
ASR Delay Time	D4-06 (VG+ only)	0.004 sec	D4-06 (VG+ only)	A1-02	--	
ASR Gain SW Freq	D4-07 (VG+ only)	0.0 Hz	D4-07 (VG+ only)	0.0 Hz	--	
ASR 1 Limit	D4-08 (VG+ only)	400%	D4-08 (VG+ only)	400%	--	
Torque Control	D5-01 (VG+ only)	0	D5-01 (VG+ only)	0	0: Speed Control	0: Speed Control
					1: Torque Control	1: Torque Control
Torque Ref Filter	D5-02 (VG+ only)	0 ms	D5-02 (VG+ only)	0 ms	--	
Speed Limit Sel	D5-03 (VG+ only)	1	D5-03 (VG+ only)	1	1: Analog Input	1: Fref Limit
					2: Program Setting	2: Speed Limit Sel
Speed Lmt Value	D5-04 (VG+ only)	105%	D5-04 (VG+ only)	0%	--	
Speed Lmt Bias	D5-05 (VG+ only)	105%	D5-05 (VG+ only)	105%	--	
Ref Hold Time	D5-06 (VG+ only)	0 ms	D5-06 (VG+ only)	0 ms	--	
Droop Quantity	D6-01 (VG+ only)	0%	--	--	--	
Droop Delay Time	D6-02 (VG+ only)	0.05 sec	--	--	--	
Dwell Ref @ Start	D8-01	0 Hz	D8-01	0 Hz	--	
Dwell Time @ Start	D8-02	0 sec	D8-02	0 sec	--	
Dwell Ref @ Stop	D8-03	0 Hz	D8-03	0 Hz	--	
Dwell Time @ Stop	D8-04	0 sec	D8-04	0 sec	--	
S-Crv Acc @ Start	D9-01	*	D9-01	0.20 sec*	Determined by X-Press Programming	
S-Crv Acc @ End	D9-02	*	D9-02	0.20 sec*	Determined by X-Press Programming	
S-Crv Dec @ Start	D9-03	*	D9-03	0.20 sec*	Determined by X-Press Programming	
S-Crv Dec @ End	D9-04	0.20	D9-04	0.00 sec	--	
Hunt Prevention Select	D11-01	1	D11-01	1	0: Disabled	0: Disabled
					1: Enabled	1: Enabled
Hunt Prevention Gain	D11-02	1.00	D11-02	1.00	--	

Product Transition Guide

IMPULSE®•G+ & VG+ Series 4

Parameter Name	Series 3		Series 4		Comments	
	No.	Default	No.	Default	Series 3	Series 4
Input Voltage	E1-01	*	E1-01	*	* Initial value determined by O2-04 (kVa selection)	
V/f Selection	E1-03 (G+ only)	0A	E1-03 (G+ only)	Determined by X-Press Programming	Range: 0-FF	0: 60 Hz, Level 0 1: 60 Hz, Level 1 2: 60 Hz, Level 2 3: 60 Hz, Level 3 4: 60 Hz, Level 4 5: 60 Hz, Level 5 6: 60 Hz, Level 6 7: 60 Hz, Level 7 8: 60 Hz, Level 8 9: 72 Hz, Level 0 A: 72 Hz, Level 1 B: 72 Hz, Level 2 C: 90 Hz, Level 0 D: 90 Hz, Level 1 E: 90 Hz, Level 2 F: Custom V/f, E1-04 through E1-13 settings define the V/f pattern, (Default for A1-03 = 2 (NLB)). When A1-03 = 0, 1, 3, or 4 and E1-03 is changed to 0F, the values for E1-04 through E1-13 are the same as E1-03 = 4. See V/f tables for appropriate voltage FF: Custom with no limitations on E1-XX.
Max Frequency	E1-04	60.0 Hz	E1-04	60.0 Hz	--	
Max Voltage	E1-05	460 V	E1-05	O2-04	--	
Base Frequency	E1-06	60 Hz	E1-06	E1-03	--	
Mid Frequency A	E1-07 (G+ only)	3.0 Hz	E1-07 (G+ only)	E1-03 Hz	--	
Mid Voltage A	E1-08 (G+ only)	30.0 V	E1-08 (G+ only)	E1-03 Hz	--	
Min Frequency	E1-09	0.0 Hz (VG+) 1.5 Hz (G+)	E1-09	0.0 Hz (VG+) 1.5 Hz (G+)	--	
Min Voltage	E1-10 (G+ only)	20.6 V	E1-10 (G+ only)	E1-03 VAC	--	
Mid Frequency B	E1-11	0.0 Hz	E1-11	0.0 Hz	--	
Mid Voltage B	E1-12	0.0 V	E1-12	0.0 VAC	--	
Base Voltage	E1-13	0.0 V	E1-13	0.0 VAC	--	
Motor Rated FLA	E2-01	*	E2-01	*	* Initial value is determined by O2-04 (kVA Selection)	

Product Transition Guide

IMPULSE®•G+ & VG+ Series 4

Parameter Name	Series 3		Series 4		Comments	
	No.	Default	No.	Default	Series 3	Series 4
Motor Rated Slip	E2-02	*	E2-02	*	* Initial value is determined by O2-04 (kVA Selection)	
No-Load Current	E2-03	*	E2-03	*	* Initial value is determined by O2-04 (kVA Selection)	
Number of Poles	E2-04	4	E2-04	4	--	
Term Resistance	E2-05	*	E2-05	*	* Initial value is determined by O2-04 (kVA Selection)	
Leak Inductance	E2-06	*	E2-06	*	* Initial value is determined by O2-04 (kVA Selection)	
Saturation Comp 1	E2-07	*	E2-07	*	* Initial value is determined by O2-04 (kVA Selection)	
Saturation Comp 2	E2-08	*	E2-08	*	* Initial value is determined by O2-04 (kVA Selection)	
Mechanical Loss	E2-09 (G+ only)	0.0%	E2-09	0.0%	--	
Motor Rated Power	E2-11	*	E2-11	*	* Initial value is determined by O2-04 (kVA Selection)	
Control Method	E3-01	0	--	--	0: V/f control	--
					2: Open loop vector	
					3: Flux Vector (VG+ only)	
Stopping Method	E3-02	1	--	--	0: Decel to Stop	--
					1: Coast to Stop	
					6: No Load Brake (E3-01 must = 3) (VG+ only)	
Max Frequency	E3-03	60.0 Hz	--	--	--	
Max voltage	E3-04	230.0 V	--	--	--	
Base Frequency	E3-05	60.0 Hz	--	--	--	
Mid Frequency	E3-06	3.0 Hz	--	--	--	
Mid Voltage	E3-07	17.2 V	--	--	--	
Min Frequency	E3-08	1.5 Hz	--	--	--	
Min Voltage	E3-09	10.3 V	--	--	--	
Motor Rated FLA	E4-01	*	--	--	* Values automatically set at Auto Tuning	
Motor Rated Slip	E4-02	*	--	--	* Values automatically set at Auto Tuning	
No Load Current	E4-03	*	--	--	* Values automatically set at Auto Tuning	
Number of Poles	E4-04	4	--	--	--	
Terminal Resistance	E4-05	*	--	--	* Values automatically set at Auto Tuning	
Leakage Inductance	E4-06	*	--	--	* Values automatically set at Auto Tuning	
Motor Rated Power	E4-07	*	--	--	* Values automatically set at Auto Tuning	
Pulses/Rev	F1-01 (VG+ only)	1024 PPR	F1-01 (VG+ only)	1024 PPR	--	

Product Transition Guide

IMPULSE®•G+ & VG+ Series 4

Parameter Name	Series 3		Series 4		Comments	
	No.	Default	No.	Default	Series 3	Series 4
PG Fdbk Loss Sel	F1-02 (VG+ only)	1	F1-21 (VG+ only)	1	0: Decel to Stop	0: Decel to Stop
					1: Coast to Stop	1: Coast to Stop
					2: Fast-Stop	2: Fast Stop
					3: Alarm Only	3: Alarm Only
PG Overspeed Sel	F1-03 (VG+ only)	1	F1-23 (VG+ only)	1	0: Decel to Stop	0: Decel to Stop
					1: Coast to Stop	1: Coast to Stop
					2: Fast-Stop*	2: Fast Stop
					3: Alarm Only	3: Alarm Only
PG Deviation Sel	F1-04 (VG+ only)	5	F1-26 (VG+ only)	5	0: @SpdAgree-Ramp	0: @Spd Agree-Decel
					1: @SpdAgree-Coast	1: @Spd Agree-Coast
					2: @SpdAgree-F-Stop*	2: @SpdAgree-F-Stop
					3: @SpdAgree-Alm	3: @Spd Agree-Alm
					4: @Run-Ramp	4: @Run-Decel
					5: @Run-Coast	5: @Run-Coast
					6: @Run-Fast Stop*	6: @Run-Fast Stop
					7: @Run-Alarm Only	7: @Run-Alarm Only
PG Rotation Sel	F1-05 (VG+ only)	0	F1-02 (VG+ only)	0	0: Fwd = C.C.W. - (B-phase at motor REV. run)	0: FWD = C.C.W. - (B-phase at motor REV. run)
					1: Fwd = C.W. - (A-phase at motor REV. run)	1: FWD = C.W. - (A-phase at motor REV. run)
PG Output Ratio	F1-06 (VG+ only)	1	F1-03 (VG+ only)	1	--	
PG Overspd Level	F1-08 (VG+ only)	105%	F1-24 (VG+ only)	115%	--	
PG Overspd Time	F1-09 (VG+ only)	0.0 sec	F1-25 (VG+ only)	0.0 sec	--	
PG Deviate Level	F1-10 (VG+ only)	10%	F1-27 (VG+ only)	10%	--	
PG Deviate Time	F1-11 (VG+ only)	0.3 sec	F1-28 (VG+ only)	0.3 sec	--	
PG # Gear Teeth1	F1-12 (VG+ only)	0	F1-04 (VG+ only)	0	--	
PG# Gear Teeth2	F1-13 (VG+ only)	0	F1-05 (VG+ only)	0	--	
PGO Detect Time	F1-14 (VG+ only)	0.5	F1-22 (VG+ only)	0.5 sec	--	
PG Ch 2 PPR	F1-16 (VG+ only)	1024 PPR	--	--	--	
PG Ch 2 Rotation	F1-17 (VG+ only)	0	----	--	0: FWD = CCW	--
					1: FWD = CW	
PGO-2-S Det Time	F1-18 (VG+ only)	0.5 sec	--	--	--	

Product Transition Guide

IMPULSE®•G+ & VG+ Series 4

Parameter Name	Series 3		Series 4		Comments	
	No.	Default	No.	Default	Series 3	Series 4
PG-Z2 Output Set	F1-19 (VG+ only)	2	--	--	0: Select by MFI=41	--
					1: Channel 1	
					2: Channel 2	
					3: Select by MFI=64	
PGO-1-H 0/1	F1-20 (VG+ only)	1	--	--	0: Disabled	--
					1: Enabled	
PGO-2-H 0/1	F1-21 (VG+ only)	0	--	--	0: Disabled	--
					1: Enabled	
PG-Z2 Input Sel	F1-22 (VG+ only)	0	--	--	0: Ch1 = motor 1, Ch 2 = motor 2	--
					1: Ch 2 = motor 2, Ch 2 = motor 1	
AI-14 Input Sel	F2-01	0	F2-01	0	0: 3ch Individual	0: 3ch Individual
					1: 3ch Additional	1: 3ch Additional
DI Option Setup	F3-01	7	--	--	0: BCD 1%	--
					1: BCD 0.1%	
					2: BCD 0.01%	
					3: BCD 1 Hz	
					4: BCD 0.1 Hz	
					5: BCD 0.01 Hz	
					6: BCD (5DG) 0.01 Hz	
7: Binary						
AO Ch1 Select	F4-01	2	F4-01	102	Range: 1 through 50 (See instruction manual for complete list)	Range: 000 through 999 (See instruction manual for complete list)
AO Ch1 Gain	F4-02	100%	F4-02	100%	--	--
AO Ch2 Select	F4-03	3	F4-03	103	--	--
AO Ch2 Gain	F4-04	50%	F4-04	50%	--	--
CH1 A0 Bias	F4-05	0.0%	F4-05	0.0%	--	--
CH2 A0 Bias	F4-06	0.0%	F4-06	0.0%	--	--
AO Opt Level CH1	F4-07	0	F4-07	0	0: 0 to 10VDC	0: 0 to 10VDC
					1: -10 to +10VDC	1: -10 to +10VDC
AO Opt Level CH2	F4-08	0	F4-08	0	0: 0 to 10VDC	0: 0 to 10VDC
					1: -10 to +10VDC	1: -10 to +10VDC
DO Ch1 Select	F5-01	F	F5-01	0	--	--
DO Ch2 Select	F5-02	F	F5-02	1	--	--
DO Ch3 Select	F5-03	F	F5-03	2	--	--
DO Ch4 Select	F5-04	F	F5-04	4	--	--
DO Ch5 Select	F5-05	F	F5-05	6	--	--
DO Ch6 Select	F5-06	F	F5-06	37	--	--
DO Ch7 Select	F5-07	F	F5-07	F	--	--
DO Ch8 Select	F5-08	F	F5-08	F	--	--

Product Transition Guide

IMPULSE®•G+ & VG+ Series 4

Parameter Name	Series 3		Series 4		Comments	
	No.	Default	No.	Default	Series 3	Series 4
DO-08 Selection	F5-09	2	F5-09	0	0: 8 ch Individual	0: 8 Ch Individual
					1: Binary Output	1: Binary Output
					2: Output per F5-01 ~ 08	2: Output per F5-01 ~ 08
					3: Serial Communication output	--
Com Bus Flt Sel	F6-01	1	F6-01	1	0: Decel to Stop	0: Decel to Stop
					1: Coast to Stop	1: Coast to Stop
					2: Fast Stop	2: Fast Stop
					3: Use B3-03 Method	3: Use B3-03 Method
EFO Detection	F6-02	0	F6-02	0	0: Always Detected	0: Always Detected
					1: Only During Run	1: Only During Run
EFO Fault Action	F6-03	1	F6-03	1	0: Decel to Stop	0: Decel to Stop
					1: Coast to Stop	1: Coast to Stop
					2: Fast Stop	2: Fast Stop
					3: Use B3-03	3: Use B3-03
Current Unit Sel	F6-05	0	--	--	0: A Display	--
					1: 100%/8192	
Torq Ref/Lmt Sel	F6-06 (VG+ only)	0	F6-06 (VG+ only)	0	0: Disabled	0: Disabled
					1: Enabled	1: Enabled
Terminal 3 Sel	H1-01	0	H1-03	Determined by X-Press Programming	Selects the multi-function inputs (see H1-06)	Selects the multi-function inputs (see H1-08)
Terminal 4 Sel	H1-02	1	H1-04	Determined by X-Press Programming	Same as H1-01	Same as H1-03
Terminal 5 Sel	H1-03	F	H1-05	Determined by X-Press Programming	Same as H1-01	Same as H1-03
Terminal 6 Sel	H1-04	F	H1-06	Determined by X-Press Programming	Same as H1-01	Same as H1-03
Terminal 7 Sel	H1-05	F	H1-07	Determined by X-Press Programming	Same as H1-01	Same as H1-03
Terminal 8 Sel	H1-06	F	H1-08	Determined by X-Press Programming	Range: 0 through 73 (See Instruction Manual for complete list)	Range: 0 through 81 (See Instruction Manual for complete list)
Terminal M0-M1 (Series 3) Term M1-M2 Sel (Series 4)	H2-01	0	H2-01	0	Same as H2-03	Same as H2-03
Terminal M2 - M3 - M4 (Series 3) Term M3-M4 Sel (Series 4)	H2-02	G+: F VG+: 0	H2-02	Determined by X-Press Programming	Same as H2-03	Same as H2-03

Product Transition Guide

IMPULSE®•G+ & VG+ Series 4

Parameter Name	Series 3		Series 4		Comments	
	No.	Default	No.	Default	Series 3	Series 4
Terminal M5-M6 Sel	H2-03	G+: F VG+: 78	H2-03	Determined by X-Press Programming	Range: 0 through FF (See Instruction Manual for complete list)	Range: 0 through 148 (See Instruction Manual for complete list)
Term A1 Lvl Sel	H3-01	0	H3-01	0	0: 0 VDC to 10 VDC	0: 0VDC to 10V
					1: -10 VDC to +10 VDC	1: -10V to +10V
Terminal A1 Gain	H3-02	100%	H3-03	100.0%	--	
Terminal 13 Bias	H3-03	0%	H3-04	0.0%	--	
Terminal A1 Bias	H3-04	0	H3-05	0	0: 0 VDC to 10 VDC	0: 0 VDC to 10V
					1: -10 VDC to +10 VDC	1: -10V to +10V
Terminal A3 Sel	H3-05	1F	H3-06	1F	Range: 1 through 1F (See instruction manual for complete list)	Range: 1 through 31 (See instruction manual for a complete list)
Terminal A3 Gain	H3-06	100.0%	H3-07	100.0%	--	
Terminal A3 Bias	H3-07	0.0%	H3-08	0.0%	--	
Term A2 Signal	H3-08	2	H3-09	2	0: 0 to +10 VDC *(Call Electromotive Systems first to modify control board).	0: 0 to +10V
					1: -10 to +10 VDC *(Call Electromotive Systems first to modify control board).	1: -10 to +10V
					2: 4 to 20mA	2: 4 to 20mA
					--	3: 0 to 20mA
Terminal A2 Sel	H3-09	1F	H3-10	0	Range: 0 through 1F (See instruction manual for complete list)	Range: 0 through 31 (See instruction manual for complete list)
Terminal A2 Gain	H3-10	100.0%	H3-11	100.0%	--	
Terminal A2 Bias	H3-11	0.0%	H3-12	0.0%	--	
Filter Avg Time	H3-12	0.00 sec	H3-13	0.03 sec	--	
Terminal FM Sel	H4-01	2	H4-01	102	Range: 0 though 50 (See Instruction Manual for complete list)	Range: 0 through 999 (See Instruction Manual for complete list)
Terminal FM Gain	H4-02	100.0%	H4-02	100.0%	--	
Terminal FM Bias	H4-03	0.0	H4-03	0.0%	--	
Terminal AM Sel	H4-04	3	H4-04	103	--	
Terminal AM Gain	H4-05	50.0%	H4-05	50.0%	--	
Terminal AM Bias	H4-06	0.0%	H4-06	0.0%	--	

Product Transition Guide

IMPULSE®•G+ & VG+ Series 4

Parameter Name	Series 3		Series 4		Comments	
	No.	Default	No.	Default	Series 3	Series 4
AO Level Select 1	H4-07	0	--	--	0: 0 to +10 VDC 1: -10 to +10 VDC 2: 4 to 20 mA	--
AO Level Select 2	H4-08	0	--	--	0: 0 to +10 VDC 1: -10 to +10 VDC 2: 4 to 20 mA	--
Serial Com ADR	H5-01	1F	H5-01	1F	--	
Serial Baud Rate	H5-02	3	H5-02	3	0: 1200 Baud 1: 2400 Baud 2: 4800 Baud 3: 9600 Baud 4: 19200 Baud 5: 38400 Baud 6: 57600 Baud 7: 76800 Baud 8: 115200 Baud	0: 1200 Baud 1: 2400 Baud 2: 4800 Baud 3: 9600 Baud 4: 19200 Baud
Serial Com Sel	H5-03	0	H5-03	0	0: No parity 1: Even parity 2: Odd parity	0: No parity 1: Even parity 2: Odd parity
Serial Fault Set	H5-04	1	H5-04	0	0: Decel to Stop 1: Coast to Stop 2: Fast-Stop 3: Alarm Only	0: Ramp to Stop 1: Coast to Stop 2: Fast-Stop 3: Alarm Only
Serial Flt Dtct	H5-05	1	H5-05	1	0: Disabled 1: Enabled	0: Disabled 1: Enabled
Transmit Wait Timt	H5-06	5ms	H5-06	5ms	--	
RTS Control Sel	H5-07	1	H5-07	1	0: Disabled (RTS is always on) 1: Enabled (RTS is ON only when sending)	0: Disabled (RTS is always on) 1: Enabled (RTS is ON only when sending)
Pulse Input Sel	H6-01	0			0: Frequency Reference 1: PID Feedback 2: PID Set Point	
Pulse In Scaling	H6-02	1440 Hz	H6-02	1440 Hz	--	
Pulse Input Gain	H6-03	100.0%	H6-03	100.0%	--	
Pulse Input Bias	H6-04	0.0%	H6-04	0.0%	--	
Pulse In Filter	H6-05	0.10 sec	H6-05	0.10 sec	--	
Pulse Moni Sel	H6-06	2	H6-06	2	--	
Pulse Moni Scale	H6-07	1440 Hz	H6-07	1440 Hz	--	
MOL Fault Select	L1-01	3	L1-01	3	0: Disabled 1: Std Fan Cooled 2: Std Blower Cooled 3: Vector Motor	0: OL1 Disabled 1: VT Motor 2: CT Motor 3: Vector motor

Product Transition Guide

IMPULSE®•G+ & VG+ Series 4

Parameter Name	Series 3		Series 4		Comments	
	No.	Default	No.	Default	Series 3	Series 4
MOL Time Const	L1-02	8.0 min	L1-02	1.0 min	--	
Mtr OH Alarm Sel	L1-03	3	L1-03	3	0: Decel to Stop (Alarm)	0: Decel to Stop (Alarm)
					1: Coast to Stop (Alarm)	1: Coast to Stop (Alarm)
					2: Fast Stop by B5-08 (Alarm)	2: Fast Stop by B5-08 (Alarm)
					3: Alarm Only (OH3 Flashes)	3: Alarm Only (OH3 Flashes)
					4: Stop by B3-03 Method (Alarm)	--
Mtr OH Fault Sel	L1-04	2	L1-04	1	0: Decel to Stop	0: Decel to Stop
					1: Coast to Stop	1: Coast to Stop
					2: Fast Stop by B5-08	2: Fast Stop by B5-08
Mtr Temp Filter	L1-05	0.20 sec	L1-05	0.20 sec	--	
PwrL Selection	L2-01	0	L2-01	0	0: Disabled	0: Disabled
					1: Enabled	1: Enbl with Timer
					2: CPU Power Active	2: Enbl whl CPU act
					--	3: KEB Mode
					--	4: KEB Stop Mode
--	5: KEB Decel to Stp					
PwrL Ride thru t	L2-02	**	L2-02	**	** Initial value is dependent on drive size, which is determined by O2-04 (kVA Selection).	
PwrL BaseBlock t	L2-03	**	L2-03	**	** Initial value is dependent on drive size, which is determined by O2-04 (kVA Selection).	
PwrL V/F Ramp t	L2-04	**	L2-04	**	** Initial value is dependent on drive size, which is determined by O2-04 (kVA Selection).	
PUV Det Level	L2-05	190/380VDC **	L2-05	E1-01	** Initial value is dependent on drive size, which is determined by O2-04 (kVA Selection).	
StallP Accel Sel	L3-01 (G+ only)	1	L3-01 (G+ only)	1	0: Disabled	0: Disabled
					1: General Purpose	1: General Purpose
					2: Intelligent	2: Intelligent
StallP Accel Lvl	L3-02 (G+ only)	150%	L3-02 (G+ only)	D10-01	--	
StallP CHP Lvl	L3-03 (G+ only)	50%	L3-03 (G+ only)	50%	--	
StallP Run Sel	L3-05 (G+ only)	1	L3-05 (G+ only)	1	0: Disabled	0: Disabled
					1: Decel Time 1	1: Decel Time 1
					2: Decel Time 2	2: Decel Time 2
Stall Run Level	L3-06 (G+ only)	160%	L3-06 (G+ only)	D10-01	--	
Spd Agree Level	L4-01	0.0 Hz	L4-01	0.0 Hz	--	
Spd Agree Width	L4-02	2.0 Hz	L4-02	2.0 Hz	--	

Product Transition Guide

IMPULSE®•G+ & VG+ Series 4

Parameter Name	Series 3		Series 4		Comments	
	No.	Default	No.	Default	Series 3	Series 4
Speed Agree Lvl ±	L4-03	0.0 Hz	L4-03	0.0 Hz	--	
Speed Agree Width ±	L4-04	2.0 Hz	L4-04	2.0 Hz	--	
TM Ctrl Method	L5-01 (VG+ only)	0	--	--	0: V/F control without PG 2: Open Loop Vector	--
TM Stop Method	L5-02 (VG+ only)	0	--	--	0: Decel to Stop 1: Coast to Stop	--
Torque Det 1 Sel	L6-01	0	L6-01	0	0: Disable 1: OT At Speed Agree-Alarm 2: OT At Run-Alarm 3: At Speed Agree-Fault 4: OT At Speed Agree-Fault 5: UT At Speed Agree-Alarm 6: UT At Run-Alarm 7: UT At Speed Agree-Fault 8: UT At Run-Fault	0: Disabled 1: OT @ SpdAgree-Alm 2: OT At RUN - Alm 3: OT @ SpdAgree-Fit 4: OT At RUN - Fit 5: UT @ SpdAgree-Alm 6: UT At RUN - Alm 7: UT @ SpdAgree-Fit 8: UT At RUN - Fit
Torq Det 1 Lvl	L6-02	150%	L6-02	150%	--	
Torq Det 1 Time	L6-03	0.1 sec	L6-03	0.1 sec	--	
Torq Det 2 Sel	L6-04	0	L6-04	0	0: Disable 1: OT At Speed Agree-Alarm 2: OT At Run-Alarm 3: OT At Speed Agree-Fault 4: OT At Run-Fault 5: UT At Speed Agree-Alarm 6: UT At Run-Alarm 7: UT At Speed Agree-Fault 8: UT At Run-Fault	0: Disabled 1: OT @ SpdAgree-Alm 2: OT At RUN - Alm 3: OT @ SpdAgree-Fit 4: OT At RUN - Fit 5: UT @ SpdAgree-Alm 6: UT At RUN - Alm 7: UT @ SpdAgree-Fit 8: UT At RUN - Fit
Torq Det 2 Lvl	L6-05	150%	L6-05	150%	--	
Torq Det 2 Time	L6-06	0.1 sec	L6-06	0.1 sec	--	
OH Pre-Alarm Lvl	L8-02	95°C	L8-02	*	* Initial value is dependent on drive size, which is determined by O2-04 (kVA selection)	

Product Transition Guide

IMPULSE®•G+ & VG+ Series 4

Parameter Name	Series 3		Series 4		Comments	
	No.	Default	No.	Default	Series 3	Series 4
OH Pre-Alarm Sel	L8-03	4	L8-03	3	0: Decel to Stop	0: Decel to Stop
					1: Coast to Stop	1: Coast to Stop
					2: Fast-Stop	2: Fast-Stop
					3: Use B3-03 Method	3: Use B3-03 Method
					4: Alarm Only	4: Alarm Only
					5: Run@L8-19 Rate	
PH Loss In Sel	L8-05	1	L8-05	1	0: Disabled	0: Disabled
					1: Enabled	1: Enabled
PH Loss Out Sel	L8-07	2	L8-07	1	0: Disabled	0: Disabled
					1: 1PH Loss Det	1: 1PH Loss Det
					2: 2/3PH Loss Det	2: 2/3PH Loss Det
Ground Fault Detect	L8-09	1	L8-09	1	0: Disabled	0: Disabled
					1: Enabled	1: Enabled
Fan On/Off Sel	L8-10	0	L8-10	0	0: Fan On-Run Mode	0: Dur Run (OffDly)
					1: Fan Always On	1: Always On
Fan Delay Time	L8-11	60 sec	L8-11	60 sec	--	
Ambient Temp	L8-12	45°C	L8-12	40°C	--	
OL2 Sel @ L-Spd	L8-15	0	L8-15	1	0: Disabled	0: Disabled
					1: Enabled	1: Enabled
Soft CLA Sel	L8-18	1	L8-18	0	0: Disabled	0: Disabled
					1: Enabled	1: Enabled
Reset Select	L9-01	1	L9-01	1	0: Disabled	0: Disabled
					1: Enabled	1: Enabled
Reset Attempts	L9-02	3	L9-02	3	--	
Reset Time	L9-03	0.5 sec	--	--	--	
Reset Flt Sel 1	L9-04	0001	L9-04	0001	--	
Reset Flt Sel 2	L9-05	E000	L9-05	F000	--	
FLT Contact Sel	L9-06	0	L9-06	0	0: No FLT Relay	0: Flt Outp Disabld
					1: FLT Relay active	1: Flt Outp Enabled
User Monitor Sel	O1-01	6	O1-01	106	Range: 4 through 53	Range: 104 through 813
Power-On Monitor	O1-02	2	O1-02	3	1: Frequency Ref	1: Frequency Ref
					2: Output Freq	2: FWD/REV
					3: Output Current	3: Output Freq
					4: User Monitor	4: Output Current
					--	5: User Monitor
Display Scaling	O1-03	0	O1-03	Determined by A1-02	0-39999	0: 0.01 Hz
						1: 0.01%
						2: RPM
						3: User Units
Display Units	O1-04	0	O1-04	Determined by A1-02		0: Hertz
						1: RPM
LCD Contrast	O1-05	3	O1-05	3	Range of 0 to 5	

Product Transition Guide

IMPULSE®•G+ & VG+ Series 4

Parameter Name	Series 3		Series 4		Comments	
	No.	Default	No.	Default	Series 3	Series 4
Mode/Service Key	O2-01	0	O2-01	0	0: Mode/Service	0: Mode/Service
					1: Remote/Local	1: Local/Remote
Oper Stop Key	O2-02	0	O2-02	0	0: Coast to Stop	0: Coast to Stop
					1: Decel to Stop	1: Decel to Stop
					2: Use B3-03 Method	2: Use B3-03 Method
User Defaults	O2-03	0	O2-03	0	0: No Change	0: No Change
					1: Set Defaults	1: Set Defaults
					2: Clear all	2: Clear all
KVA Selection	O2-04	Default determined by kVa rating	O2-04	Default determined by drive capacity	Range: 0–F, 10, 20–37 (See Instruction Manual for complete list)	Range: 0x00 ~ 0xFF (See Instruction Manual for complete list)
Operator M.O.P	O2-05	0	O2-05	0	0: Disabled	0: Disabled
					1: Enabled	1: Enabled
Oper Detection	O2-06	1	O2-06	1	0: Disabled	0: Disabled
					1: Enabled	1: Enabled
Elapsed Time Set	O2-07	0	O3-01	0hr	--	
Elapsed Time Run	O2-08	1	O3-02	1	0: Power-On Time	0: Power-On Time
					1: Running Time	1: Running Time
Fan ON Time Set	O2-10	0	--	--	0: Disabled	--
					1: Enabled	--
Flt Trace Clear	O3-01	0	--	--	0: Not Clear	--
					1: Clear U2/U3	--
Count Hist Clear	O3-02	0	--	--	0: Not Clear	--
					1: AC Count Clr	--
					2: OL/LC Count Clr	--
					3: Both Count Clr	--
Copy Function Sel	O4-01	0	O4-01	0	0: Copy Select	0: Copy Select
					1: Inv → OP Read	1: Inv → OP Read
					2: OP → Inv Write	2: OP → Inv Write
					3: OP ↔ Inv Verify	3: OP ↔ Inv Verify
Read Allowable	O4-02	1	O4-02	1	0: Disabled	0: Disabled
					1: Enabled	1: Enabled

Page Intentionally Left Blank

IMPULSE[®]•G+ & VG+ Series 3 to Series 4 Product Transition Guide

Data subject to change without notice.



Magnetek, Inc.
N49 W13650 Campbell Drive
Menomonee Falls, WI 53051

Distributed by Ergonomic Partners
Sales@ErgonomicPartners.com
www.ErgonomicPartners.com
Tel: (314) 884-8884

Document Number: 144-27371
August 2011
Magnetek, Inc. ©